

IRSN

INSTITUT
DE RADIOPROTECTION
ET DE SÛRETÉ NUCLÉAIRE

Faire avancer la sûreté nucléaire

Combined exposures to stable and radioactive substances for ecological risk assessment

Rodolphe GILBIN, Laureline FÉVRIER, Catherine LECOMTE, Frédéric ALONZO, Béatrice GAGNAIRE, Jean-Marc BONZOM, Olivier ARMANT, Karine BEAUGELIN, Hugo LEPAGE, Jacqueline GARNIER-LAPLACE

Rodolphe GILBIN

rodolphe.gilbin@irsn.fr

**Research Department on Transfers and Effects of
Radionuclides on ecosystems
IRSN / PSE-ENV / SRTE
Cadarache, France**



Introduction

1

- Exposure in ecosystems: Many substances (stable or radioactive) at potential risk
- Ecotoxicity of substances: approach by 1 (substance, organism) to determine toxic effects
- Protection target for ecological risk assessment: species assemblages, ecosystem structure and function sensitivity to all variables (contaminants and other environmental factors)

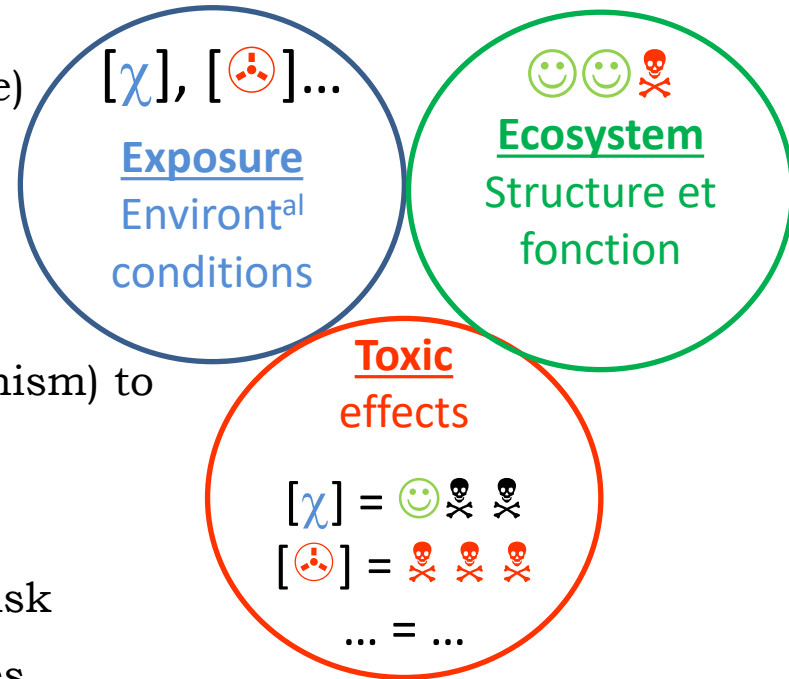

1- Introduction

Joint exposure to stable and radioactive substances

Example of stable and radioactive substances present in releases from nuclear fuel cycle facilities

Vandenhove *et al.* (2012) STAR D 4.1

	Substances Stables	Radioactives
U mining (ex. Canada, Germany, Brazil, France)	As, Cd, Cr, Cu, Pb, Zn Ba, Fe, Al, F, Cl	U and daughters
Nuclear Fuel Production	F, NH ₄ , K, SO ₄ , As, Cl, Cr, Cu, Fe, Zn	¹⁴ C, ³ H, ⁹⁹ Tc, α, β
Electric power production	NH ₄ , B, Cu, Zn, LiOH Morpholine, hydrazine ...	^{110m} Ag, ¹⁴ C, ⁵⁸ Co, ^{134/7} Cs, ³ H, ¹³¹ I, ⁵⁴ Mn, ^{124/5} Sb, ^{123m} Te
Spent fuel reprocessing (ex. AREVA-NC La Hague)	TBP, NO ₃ , hydrazine, NH ₄ , SO ₄ , Fe, K, Ba, Al, F, Co, Cd, Ni, Cr, Hg, Pb, Zr	¹⁴ C, ³ H, ⁸⁵ K, ⁶⁰ Co, ^{134/7} Cs, I, ¹⁰⁶ Ru, ⁹⁰ Sr, ⁶⁰ Ni, ²³⁸⁻⁴¹ Pu, ¹⁰⁶ Rh, ¹²⁵ Sb, ²⁴¹ Am, ²²⁴⁴ Cm, U
Waste disposal
NORM (coal, petrol, gaz, minerals extraction...; <i>Hospitals, R&D</i> <i>Accidents</i> <i>Other industries, agriculture, non-point sources...</i>	metals, hydrocarbons...	natural RNs

1- Introduction

Approaches developed at IRSN

Determination of the **ecological structure**
(species assemblages) **and function**
(integrated biomarker response)

Cumulative Risk Assessment (msPAF
approach for the prediction of chronical
impact to aquatic ecosystem)

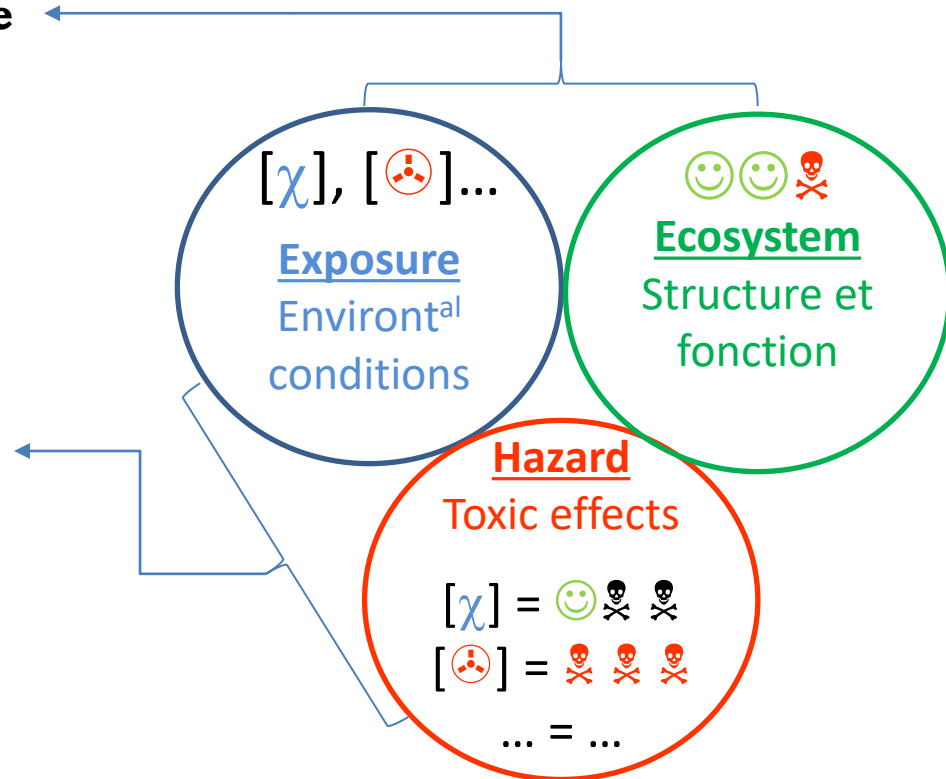

Cumulative Risk Assessment

2



Example : routine releases
of NPPs in the Rhône river

Beaumelle et al. (2017), *Environ. Poll.* 231:1421-32

IPOTOMUS project (in progress)

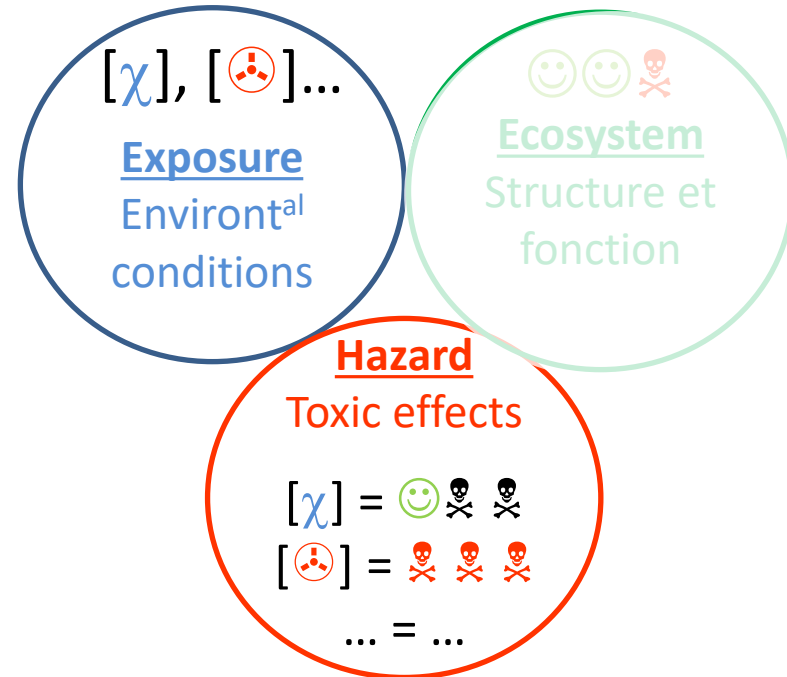

2- Cumulative Risk Assessment

Methods : Species Sensitivity Distribution (SSD)

- **Cumulated Distribution Function (CDF)** of chronic (or acute) ecotoxicological data (NOEC, EC10...) for *all** species
- Expresses the **fraction of species potentially affected (PAF)** by the exposure to a given stressor
- Widely used to account for the **variation in species sensitivity** (De Zwart & Posthuma, 2005)

& to derive **maximum acceptable concentration** of a substance
(e.g. HC5 : Hazardous Concentration that affect 5% of species)

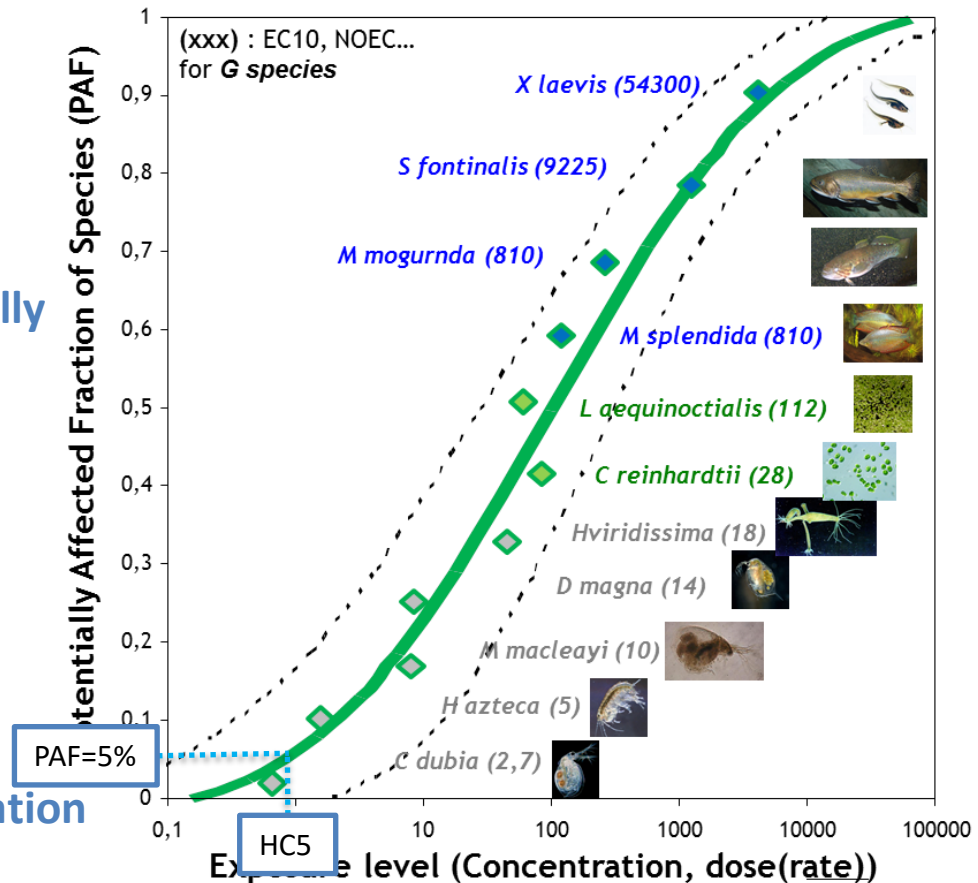

➔ **Consistent benchmark derivation for substances**

2- Cumulative Risk Assessment

Methods : Multi-Substances SSDs (msPAF)

SSDs recommended to provide an **integrated indicator** of the potential ecological risk of a mixtures: **msPAF** (multi-substance Potentially Affected Fraction of species)
(De Zwart and Posthuma, 2005)

SSD derivation: every stable substance ionizing radiation

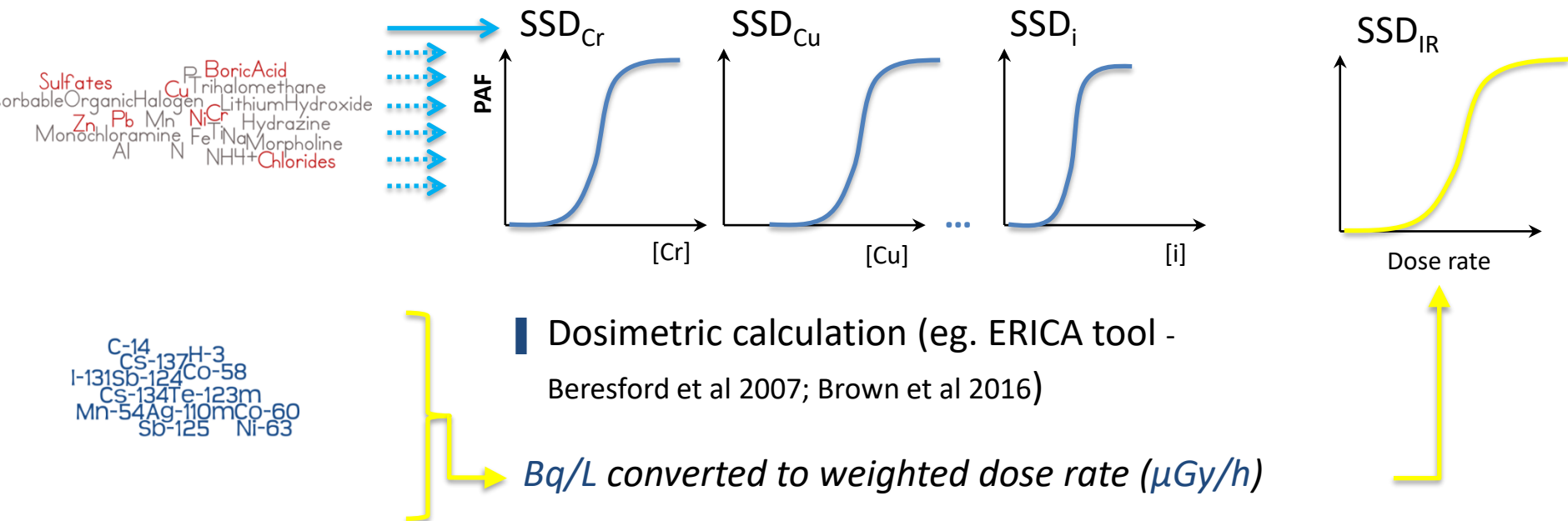

2- Cumulative Risk Assessment

Methods : SSDs combination (1/2)

Independent Action (IA)

- stressors considered independently
- PAF calculation for each stressor
- msPAF computed as following :

$$msPAF_{IA} = 1 - \prod_{i=1}^n (1 - PAF_i)$$

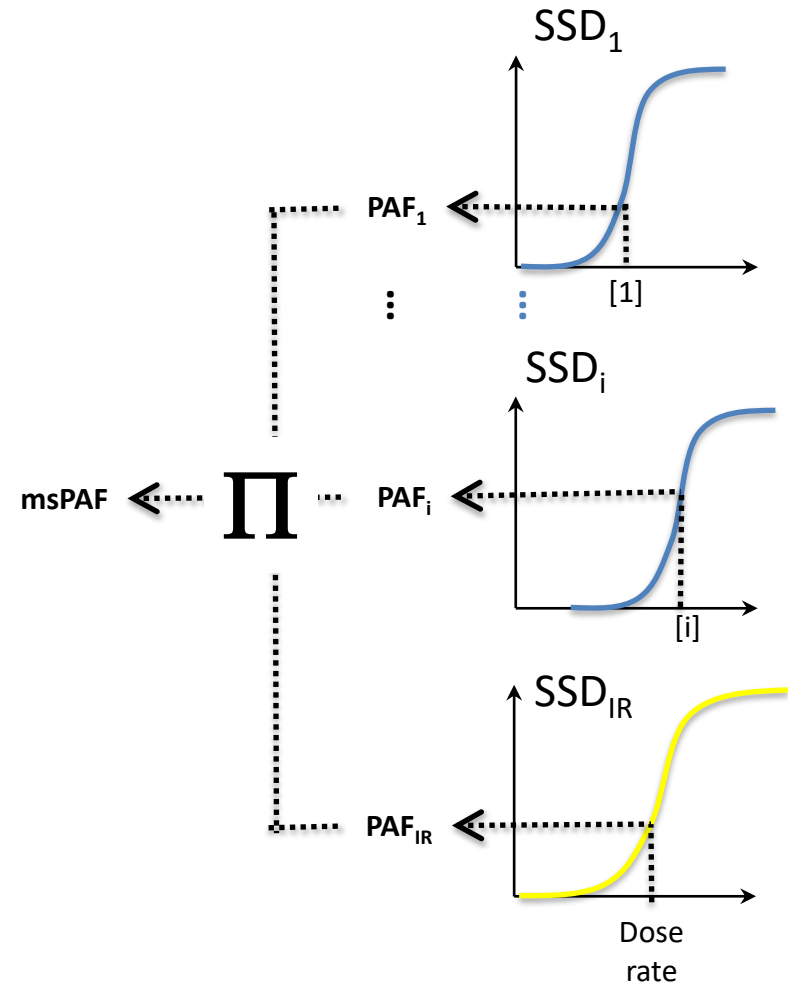

2- Cumulative Risk Assessment

Methods : SSDs combination (2/2)

Concentration Addition (CA)

- all SSDs normalized to their toxic potential (HC50)
- exposure expressed as Hazard unit (HU)
- 1 single average SSD for all stressor
- msPAF computed as following :

$$\sum HU = \sum_{i=1}^n \frac{C_i}{HC50_i}$$

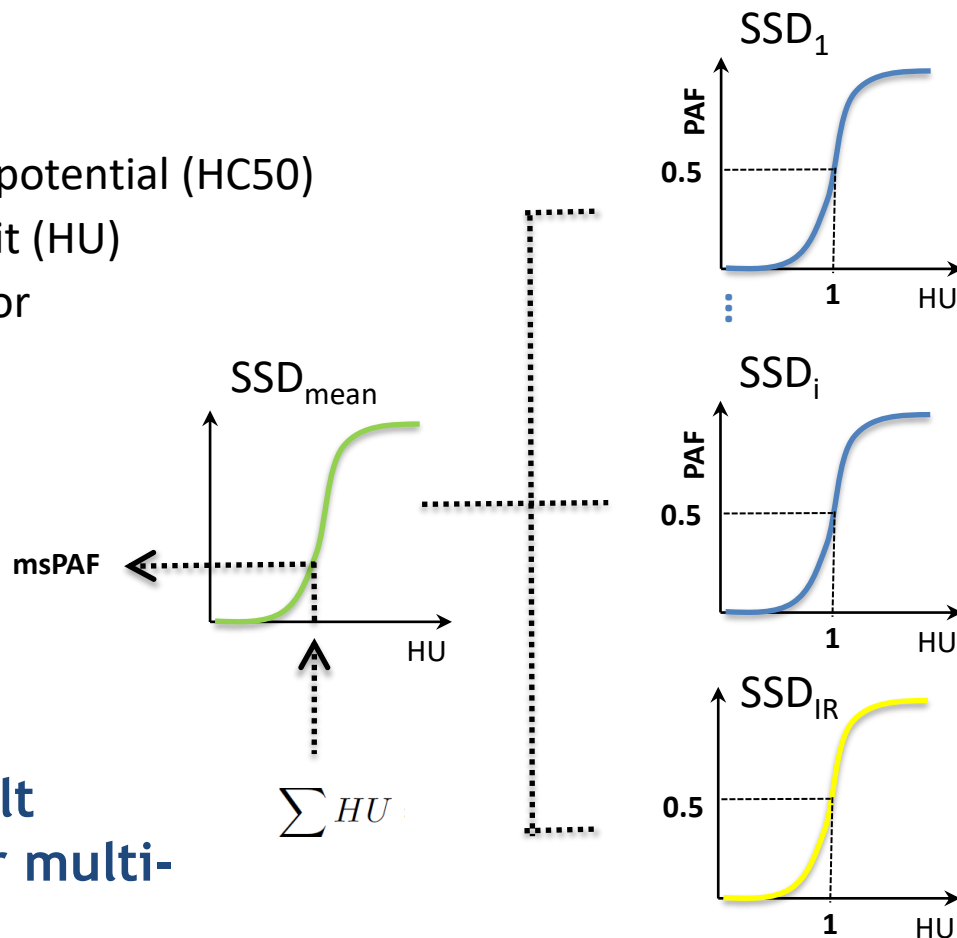

➔ recommended as the default (conservative) approach for multi-substance Risk Assessment

(Backaus et al., 2000)

2- Cumulative Risk Assessment

Case study : NPPs routine releases

Rhône river catchment
(SE France)



4 NPPs

Bugey

4x900 MW
130-457 m³/s

St Alban

2x1300 MW
255-1040 m³/s

Cruas

4x900 MW
400-1500 m³/s

Tricastin

4x900 MW
300-1500 m³/s

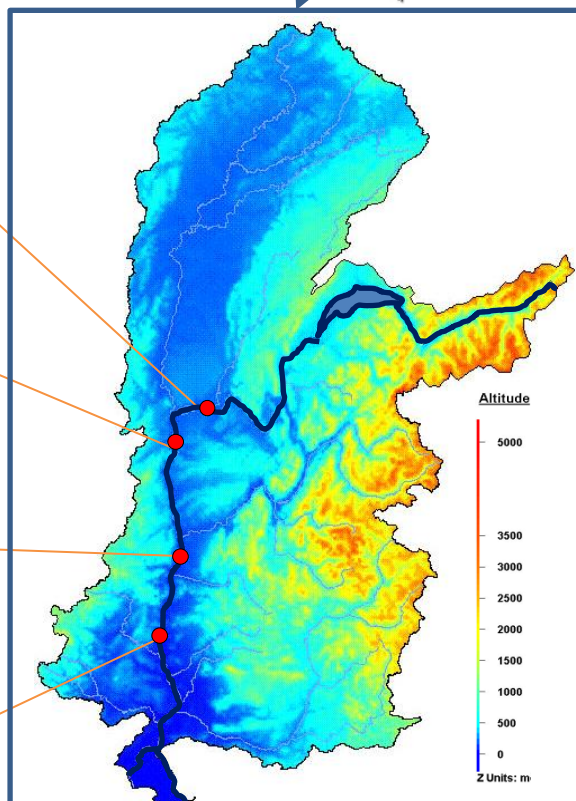

Annual released quantities (Q_i)
under normal operating conditions

(EDF, 2013)

Q _i (kg or GBq)	Bugey	Tricastin	Cruas	St-Alban	
Cr			1		stable substances
Cu	17	2	15 100	1	
Ni			1		
Pb		1	1		
Zn	7	9	6 600	4	
Boric acid	9 000	9 050	13 700	3 730	
Chlorides	44 200	13 900		33 000	
Sulfates	142 000	98 000	3 967 000		
Ag-110m	0.47	0.05	0.13	0.01	radioactive substances
C-14	38.00	45.00	47.00	31.00	
Co-58	0.45	0.06	0.13	0.04	
Co-60	0.10	0.16	0.18	0.07	
Cs-134	0.02	0.03	0.04	0.01	
Cs-137	0.02	0.04	0.04	0.01	
H-3	44 300.00	51 300.00	58 300.00	55 600.00	
I-131	0.02	0.03	0.03	0.01	
Mn-54	0.02	0.04	0.04	0.01	
Ni-63	0.13	0.07	0.19	0.14	
Sb-124	0.05	0.03	0.03	0.01	
Sb-125	0.08	0.09	0.09	0.03	
Te-123m	0.01	0.04	0.04	0.01	

2- Cumulative Risk Assessment

Case study : NPPs routine liquid releases

average annual conc. (C_i) ←

4 NPP considered

2 dilution scenarios

- mean flow rate
- minimum flow rate

$$C_i = \frac{Q_i F_{rel}}{V_{tot} F_{riv}}$$

C_i	concentration/activity in river (Bq/L)
Q_i	cumulated annual release (Bq or kg)
V_{tot}	volume of liquid effuents (L)
F_{rel}	flow rate of the releases (m ³ /s)
F_{riv}	flow rate of the Rhône river (m ³ /s)

➔ 8 contrasted scenarios
(dilution, mixture composition)

Annual released quantities (Q_i)
under normal operating conditions

(EDF, 2013)

Q_i (kg or GBq)	Bugey	Tricastin	Cruas	St-Alban	
Cr			1		stable substances
Cu	17	2	15 100	1	
Ni			1		
Pb		1	1		
Zn	7	9	6 600	4	
Boric acid	9 000	9 050	13 700	3 730	
Chlorides	44 200	13 900		33 000	
Sulfates	142 000	98 000	3 967 000		
Ag-110m	0.47	0.05	0.13	0.01	radioactive substances
C-14	38.00	45.00	47.00	31.00	
Co-58	0.45	0.06	0.13	0.04	
Co-60	0.10	0.16	0.18	0.07	
Cs-134	0.02	0.03	0.04	0.01	
Cs-137	0.02	0.04	0.04	0.01	
H-3	44 300.00	51 300.00	58 300.00	55 600.00	
I-131	0.02	0.03	0.03	0.01	
Mn-54	0.02	0.04	0.04	0.01	
Ni-63	0.13	0.07	0.19	0.14	
Sb-124	0.05	0.03	0.03	0.01	
Sb-125	0.08	0.09	0.09	0.03	
Te-123m	0.01	0.04	0.04	0.01	

2- Cumulative Risk Assessment

Average SSD derivation (for CA approach)

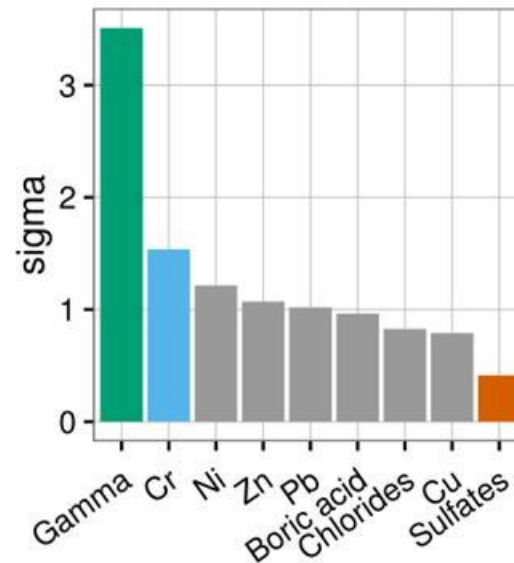
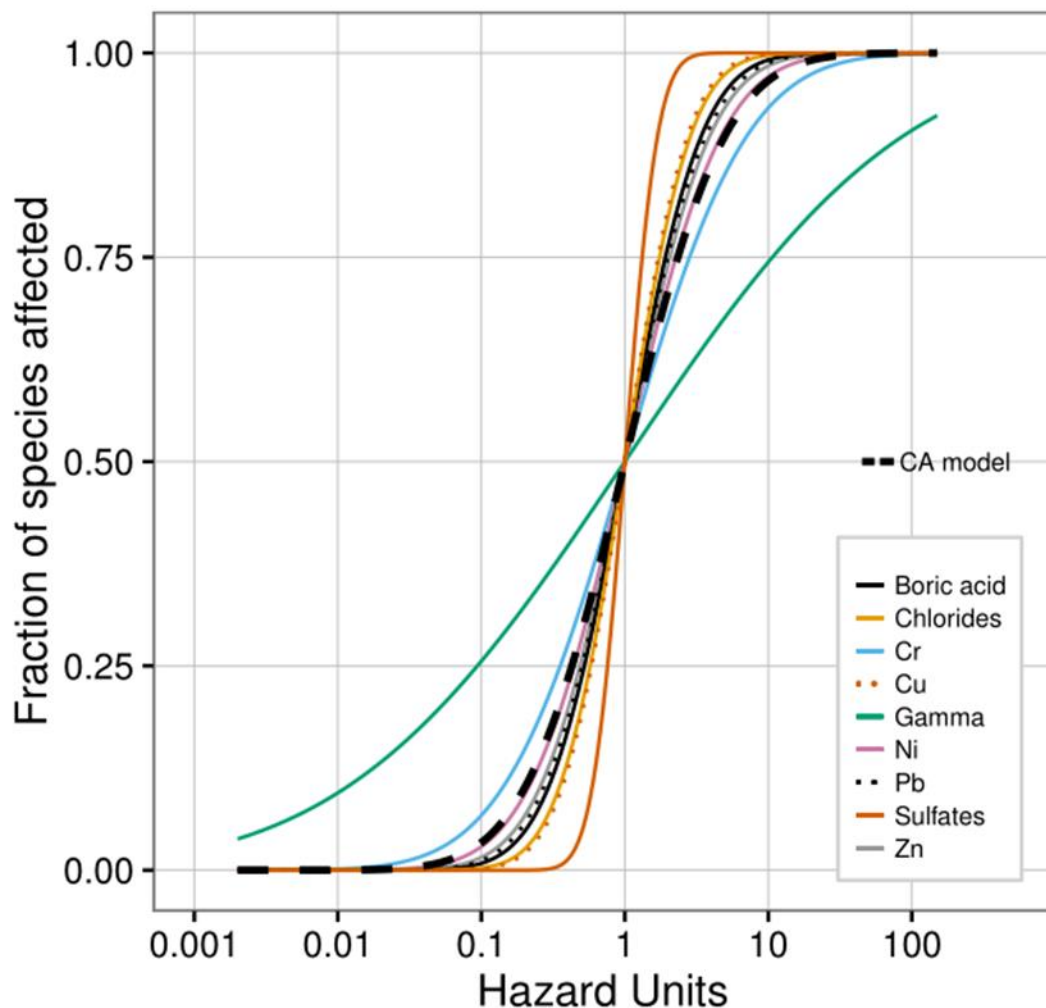

Statistically relevant groups = similar slopes (Bartlett test)

➔ 3 msPAF calculations

CA

Conc. Addition

IA

Independent Action

CA&IA

4 CA groups, then IA

2- Cumulative Risk Assessment

msPAF calculation results

msPAFs associated with different release scenarios using

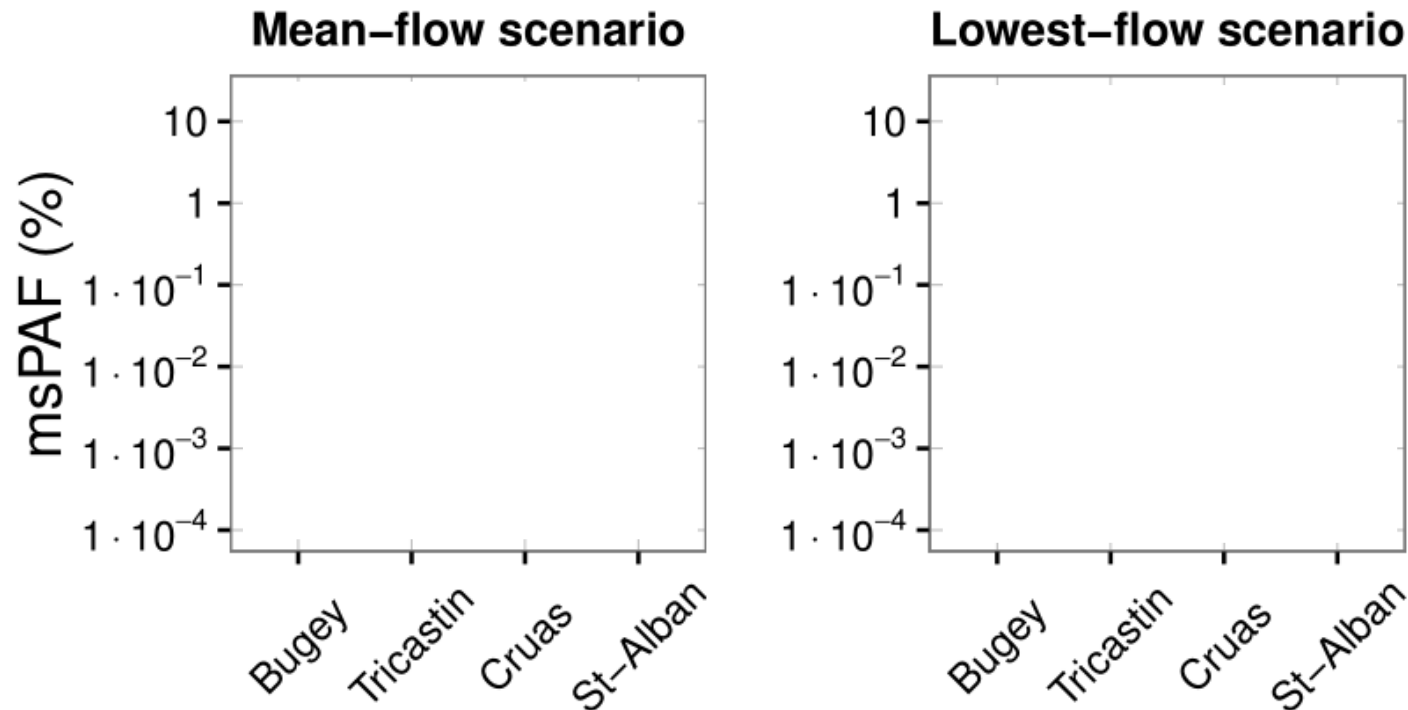

- very low risk level : $msPAF \ll 5\%$ except 1 case (Cruas with CA)
- No difference between CA and CAIA
- Surprisingly, CA not always conservative due to the differences in SSD slopes

➔ Use of both concepts (CA and IA) to provide a “prediction window”

2- Cumulative Risk Assessment

msPAF calculation results

msPAFs associated with different release scenarios using

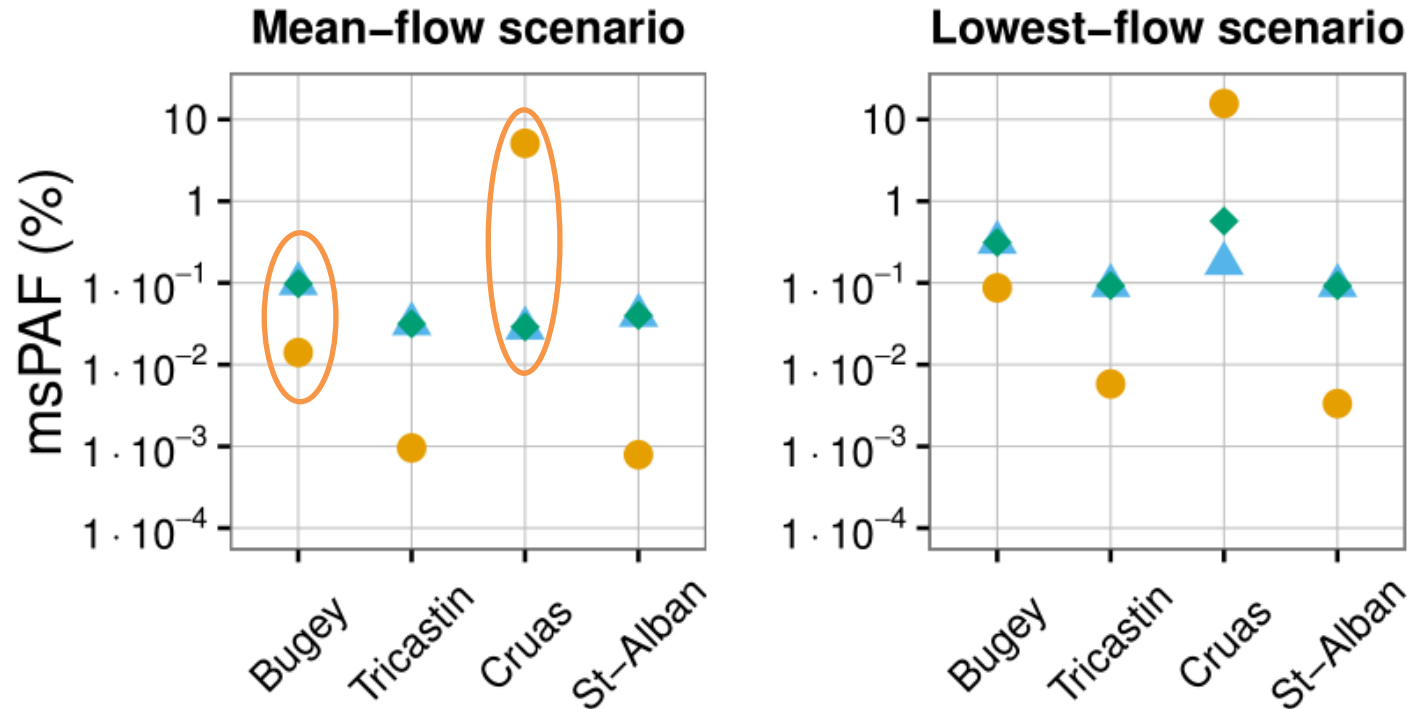

➔ **Contribution of the different stressors to the overall msPAF ?**
eg. contrasted cases of Bugey and Cruas (mean flow)

2- Cumulative Risk Assessment

Stressors combination and ranking

- Concentration Addition

$$HU_i = \frac{C_i}{HC_{50i}}$$

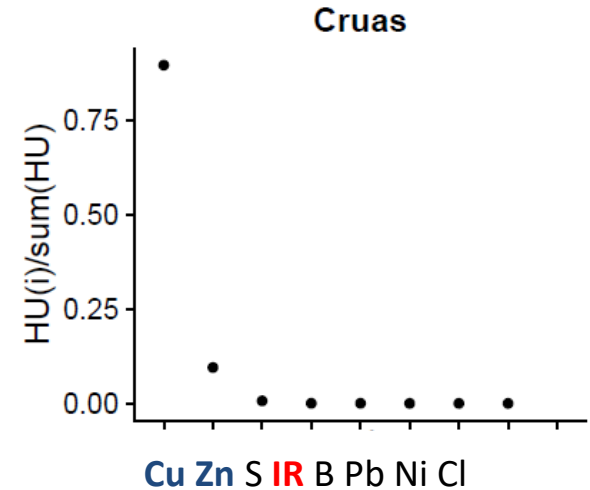
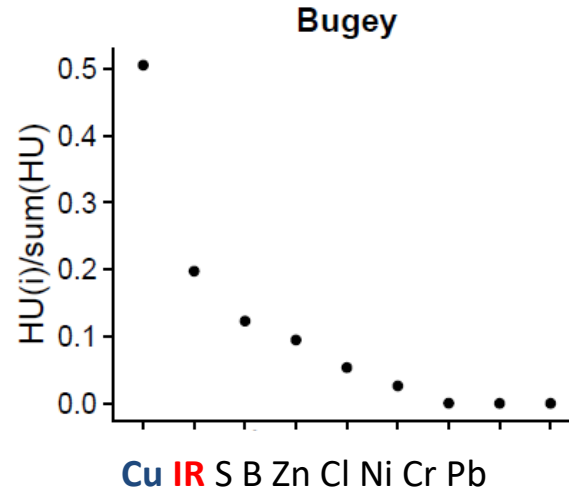

- ▲ Independant Action

individual PAF for each stressor/group

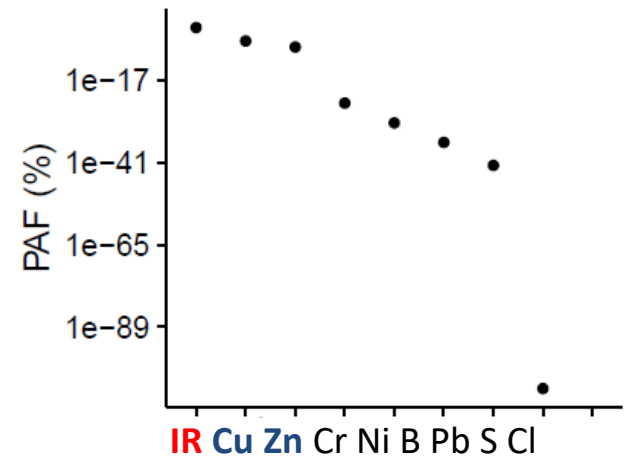
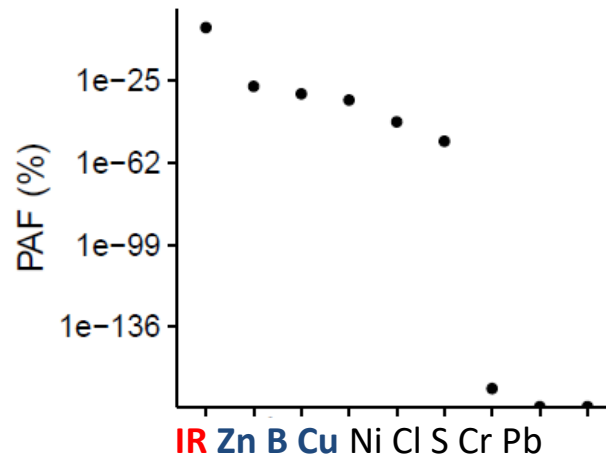

➔ Different ranking as a function of the considered model (CA or IA)

2- Cumulative Risk Assessment

Conclusion (1/2)

Very different SSD shapes (ionising radiation vs. stable chemicals)

CA is not the most conservative

→ Considering both CA and IA mixture models to provide a prediction window

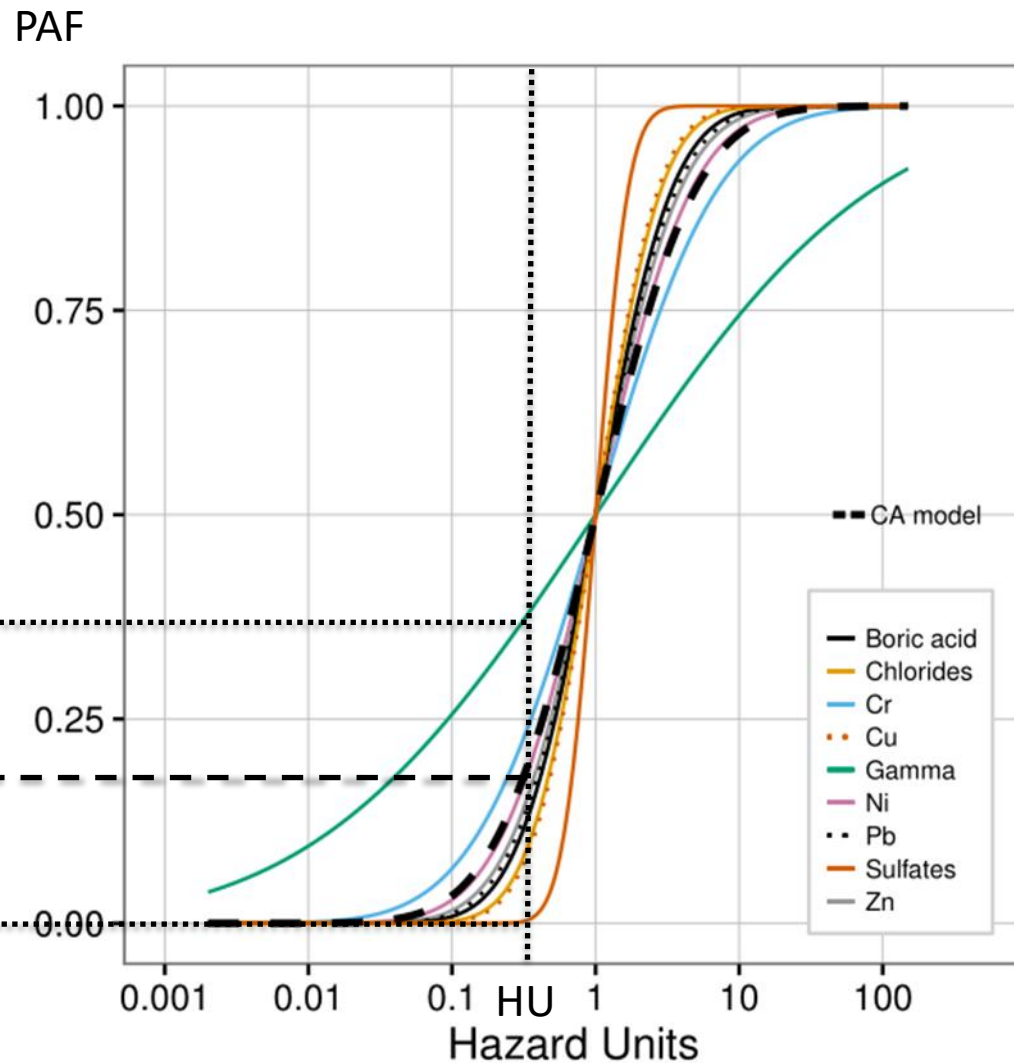
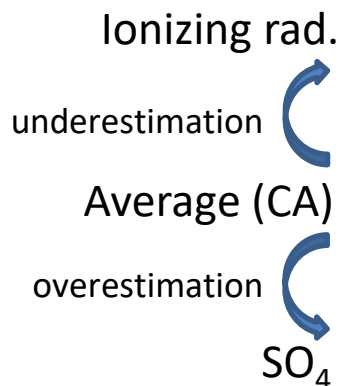

2- Cumulative Risk Assessment

Conclusion (2/2)

- **Negligible overall potential ecological risk** in the context of routine effluents releases in aquatic ecosystems (except msPAF exceeding 5% in 1 case)

- msPAF **does not provides directly information about the contribution / ranking** of each stressor
 - ionizing radiation dominates the contribution to PAF (IA)
 - stable chemicals (mainly Cu, Zn) dominates contribution to HU (CA)

- Main limitations (and perspectives)
 - **Unsufficient ecotoxicity datasets** for some substances cannot allow a robust SSDs derivation (only 8 among 22 stable chemicals considered)
 - ➔ In progress (**Ipotomus Project**): use of monitoring data (chemical, radioactive) and the Δ PAF approach (> chemicals considered: 84 among 1046)
 - **Limited ecological relevance** (needs validation with field data)
 - Do not consider **realistic exposure conditions** (bioavailability, competitions...)
 - Do not consider **potential interactions** (synergism, antagonism)

Mixture Exposure and Ecological status



Example : releases from former U mines in France

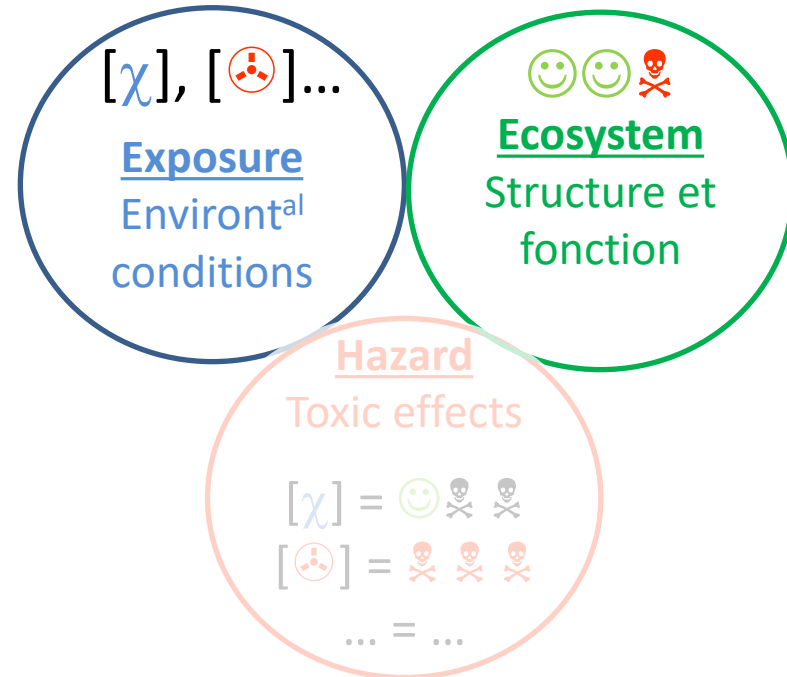

3- Mixture exposure and diatom community diversity

Example : Ritord, releases from former uranium mine sites

Herlory et al. (2013) *Ecotoxicology*

- Objective: to determine the **diversity and quality of species assemblages**
- Methodology: **Benthic diatoms** (community distribution and ecological preferences)
- Data set: **7-month monitoring** (July-January), monthly sampling
 - environmental conditions, contaminants
 - biomass, photosynthesis, specific composition of diatom assemblages

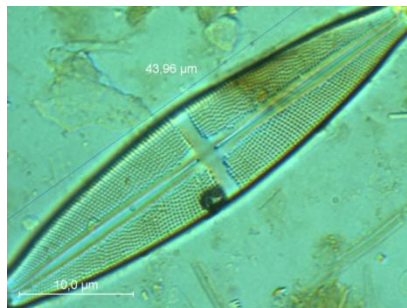
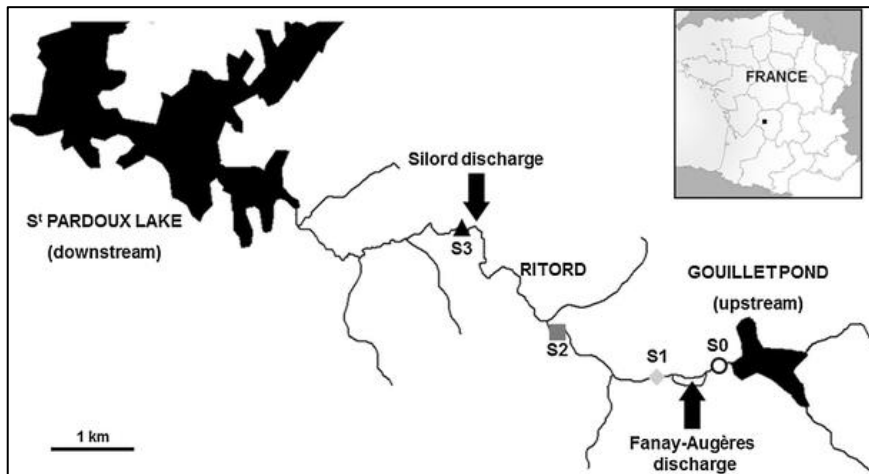

3- Mixture exposure and diatom community diversity

Example : Ritord, releases from former uranium mine sites

▪ Environnemental conditions

T°, pH, conductivity, O₂, ORP (redox)

Nutrients (Si, NO₂, NH₄, NO₃, SO₄, Cl)

Carbon inorg. (TIC) et organique (TOC)

Cations (Ca, K, Mg, Na)

Metals diss and bioacc (U, Al, Ba, Fe, Mn)

▪ Specific composition of diatom assemblies



→ Specific identification and abundance (microscopy after cleaning)

Herlory et al. (2013) *Ecotoxicology*

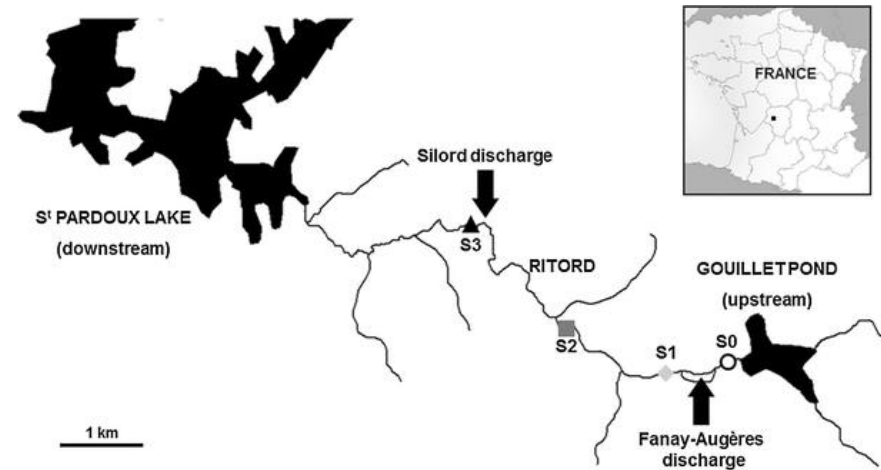

12km (1m prof.), BV 17km²
connects 2 ponds (Gouillet → St Pardoux)

7 former mines, collect and treatment of effluents (Fanay-Augères, Silord) : BaCl₂ (²²⁶Ra↓), Al₂(SO₄)₃ (Fe, U ↓)

4 stations :

- | | |
|---|------------------------|
| ○ | S0 (upstream) |
| ◇ | S1 (downs. Fanay) |
| ■ | S2 (mid-course) |
| ▲ | S3 (downstream Silord) |

3- Mixture exposure and diatom community diversity

Example : Ritord, releases from former uranium mine sites

Herlory et al. (2013) Ecotoxicology

■ Environnemental conditions

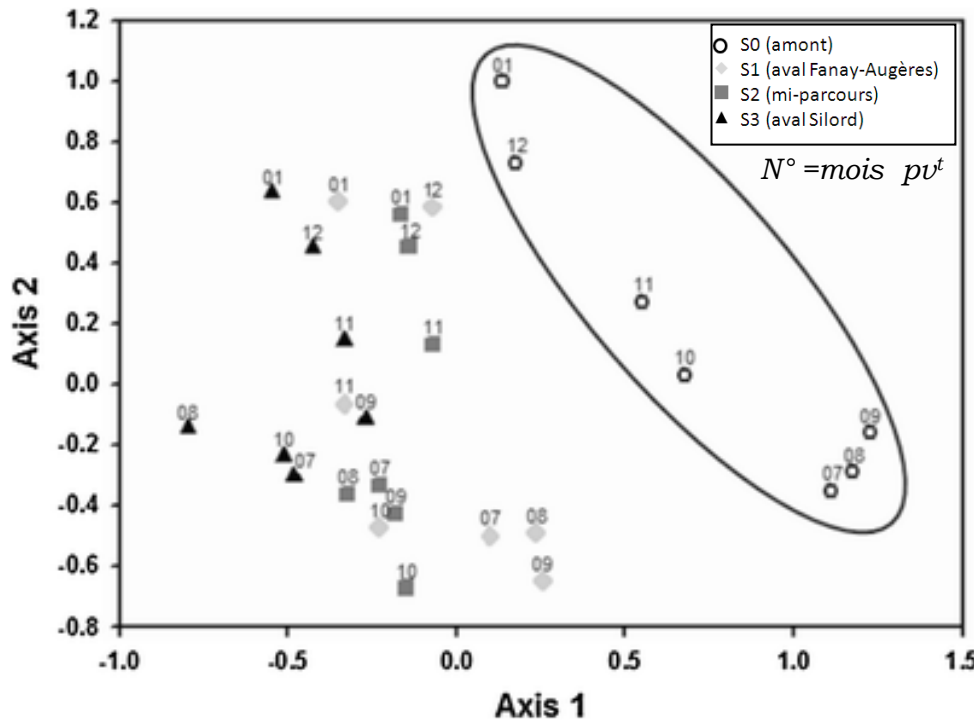

Axis 1		Axis 2	
Variable	ρ_s	Variable	ρ_s
Al accumulated	-0.82	TIC	-0.85
Cl	-0.77	Conductivity	-0.83
pH	-0.67	Temperature	-0.79
Ba accumulated	-0.59	O ₂ dissolved	0.44
Mn accumulated	-0.46	Stream water flow	0.64
Na	-0.45	ORP	0.82
Ba dissolved	-0.41		
U dissolved	-0.39		
NH ₄	0.62		
Fe dissolved	0.65		
Fe accumulated	0.77		

NMDS (Non-metric multidimensional scaling)

ρ_s : corrélation de Spearman (rang) entre les coordonnées de l'échantillon et les variables

- **S0 (upstream) significantly different** from other stations (PERMANOVA)
- Effect of **contamination (Axis 1)**: U and treatment effect (Ba, Al, Mn, pH)
- **'Season' effect (Axis 2)**: ICT, Cond, redox, T °, flux, O₂

3- Mixture exposure and diatom community diversity

Example : Ritord, releases from former uranium mine sites

■ Diatom Species composition

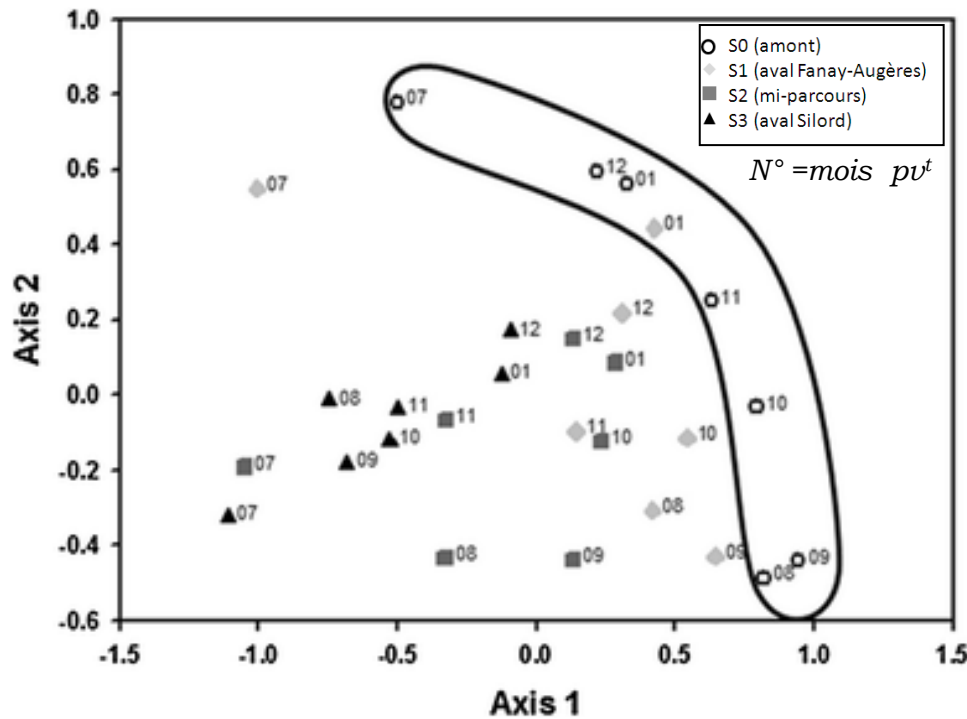

■ **No effect on specific wealth** ($S = 55$ to 74), diversity ($H' = 2,5$ to $3,2$), biomass or photosynthesis

■ **Differences in community composition** (S0 differ from other stations, "indicator species")

Herlory et al. (2013) Ecotoxicology

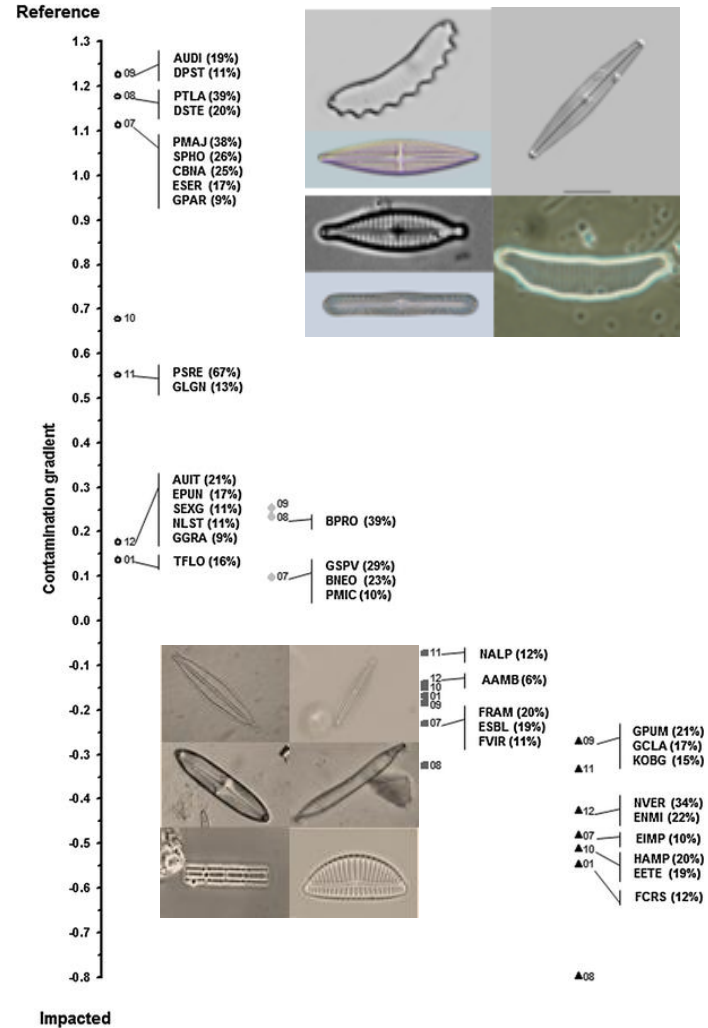

3- Mixture exposure and diatom community diversity

Example : Ritord, releases from former uranium mine sites

- Diatom community composition differences attributed to the variables characterizing the **effluents 'as a whole'**
- **U, but also** Cl, Ba, Al, Mn ...
- Role of uranium vs. other environmental variables on Diatom community composition ?
- Interactions between substances?
- Actual exposure and bioavailability conditions (pH changes, conductivity, redox ...)?

ρ_S : Spearman correlation (rank) between similarity matrices 'Specified composition' and 'Environmental conditions'

Herlory et al. (2013) Ecotoxicology

Variable	ρ_S
<i>Corrélations individuelles</i>	
Cl	0.466***
<u>U</u> _{diss}	0.377***
Ba _{diss}	0.321***
ORP (redox)	0.294***
Conductivity	0.273**
Al _{acc}	0.258**
Mn _{diss}	0.270**
Ba _{acc}	0.250**
TIC	0.151**
Na	0.165**
Fe _{acc}	0.249**
NH ₄	0.176**
Temperature	0.168*
Mn _{acc}	0.188*
Fe _{diss}	0.211*
pH	0.165*
Flow	0.088*
TOC, SPM, O ₂ , Al	NS

BIO-ENV procedure, (Clarke and Ainsworth, 1993)

*** $p \leq 0.001$; ** $p \leq 0.01$; * $p \leq 0.05$

Mixture Exposure and Ecological status

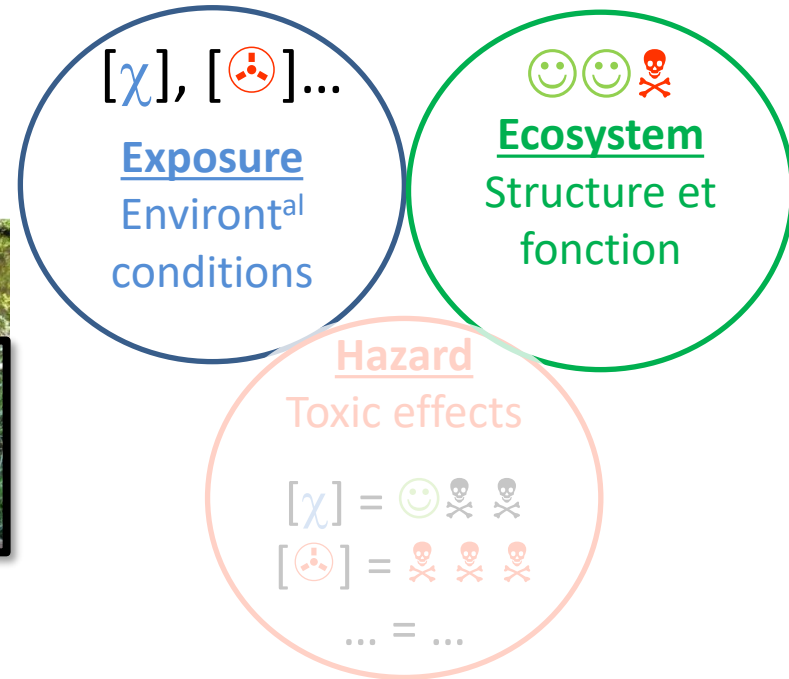

Other examples on fish :

Integrated Biomarker Response
 Approach

3- Integrated Biomarker Response approach

Responses on stickleback health



**Le Guernic et al. (2016),
Ecotoxicology 25(8):1478-99**

Three-spined stickleback
(*Gasterosteus aculeatus*)

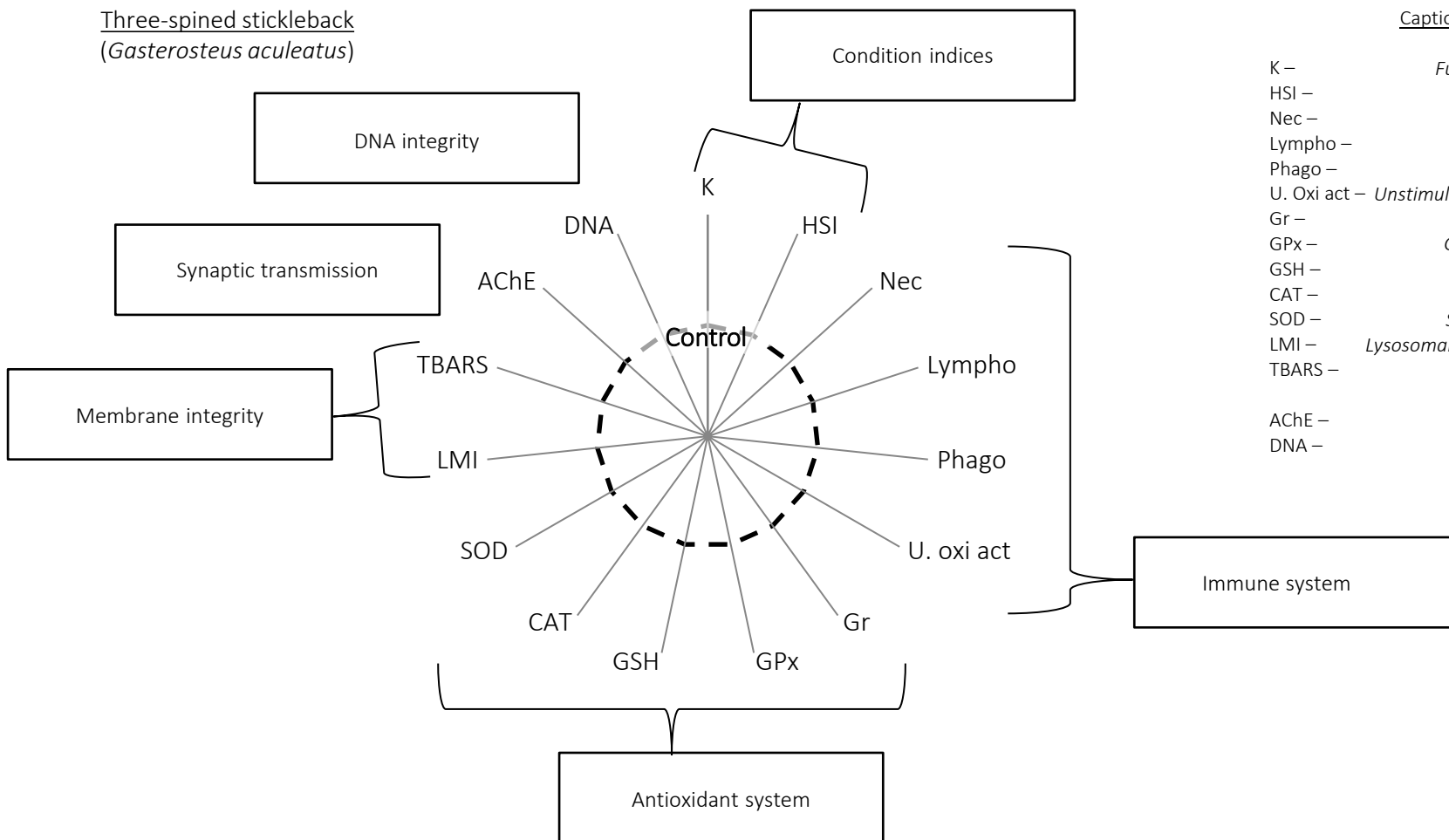

3- Integrated Biomarker Response approach

Responses on stickleback health

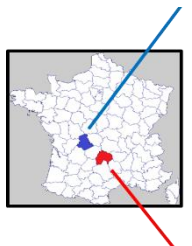

		U	Al	Fe	Mn	Ba
		µg/L				
Haute Vienne	Pontabrier	23.5	82.7	263.6	52.2	18.5
	Malessard	0.3	44.9	82.0	16.1	6.4
	JSM	0.1	48.7	396.6	27.1	22.1
Cantal	Saint-Pierre	5.9	44.1	165.7	218.1	16.5
	Madic	0.1	137.0	466.4	44.3	40.5
	Etang Noir	0.2	202.2	295.0	28.7	21.2

Le Guernic et al. (2016),
Ecotoxicology 25(8):1478-99

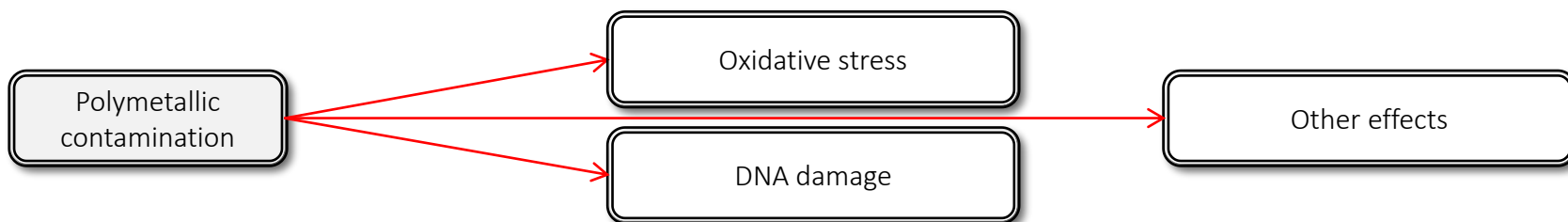
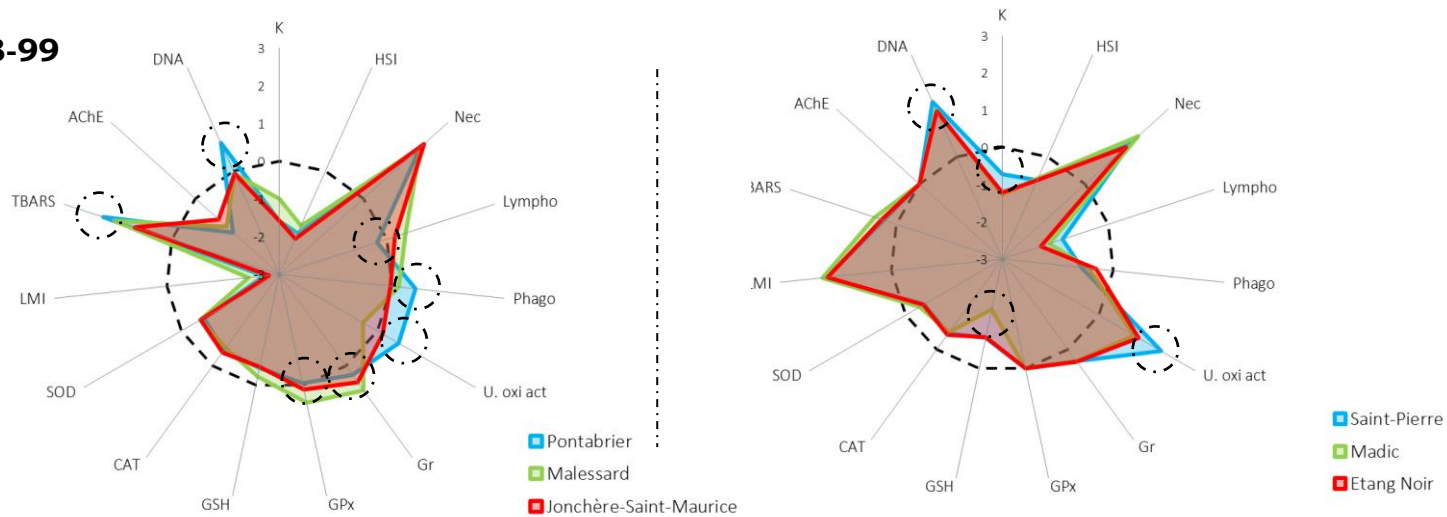

3- Integrated Biomarker Response approach

Responses on fathead minnow



[Tritium] from 4 to 12000 Bq/L (max=0.15 μ Gy/h) - Chalk River Laboratory (CNL)
60 days contamination + 60 days depuration

Fathead minnow
(*Pimephales promelas*)

- Redundancy Discriminant Analysis (RDA) with all biomarkers data
→ Positive correlation of responses (LMI, μ N, comet, H2AX, muscle AChE, SOD, CAT, fatty acids) with tritium exposure (despite very low dose-rate estimates)
- Lower correlation (few biomarkers) linked with metals (PC1)

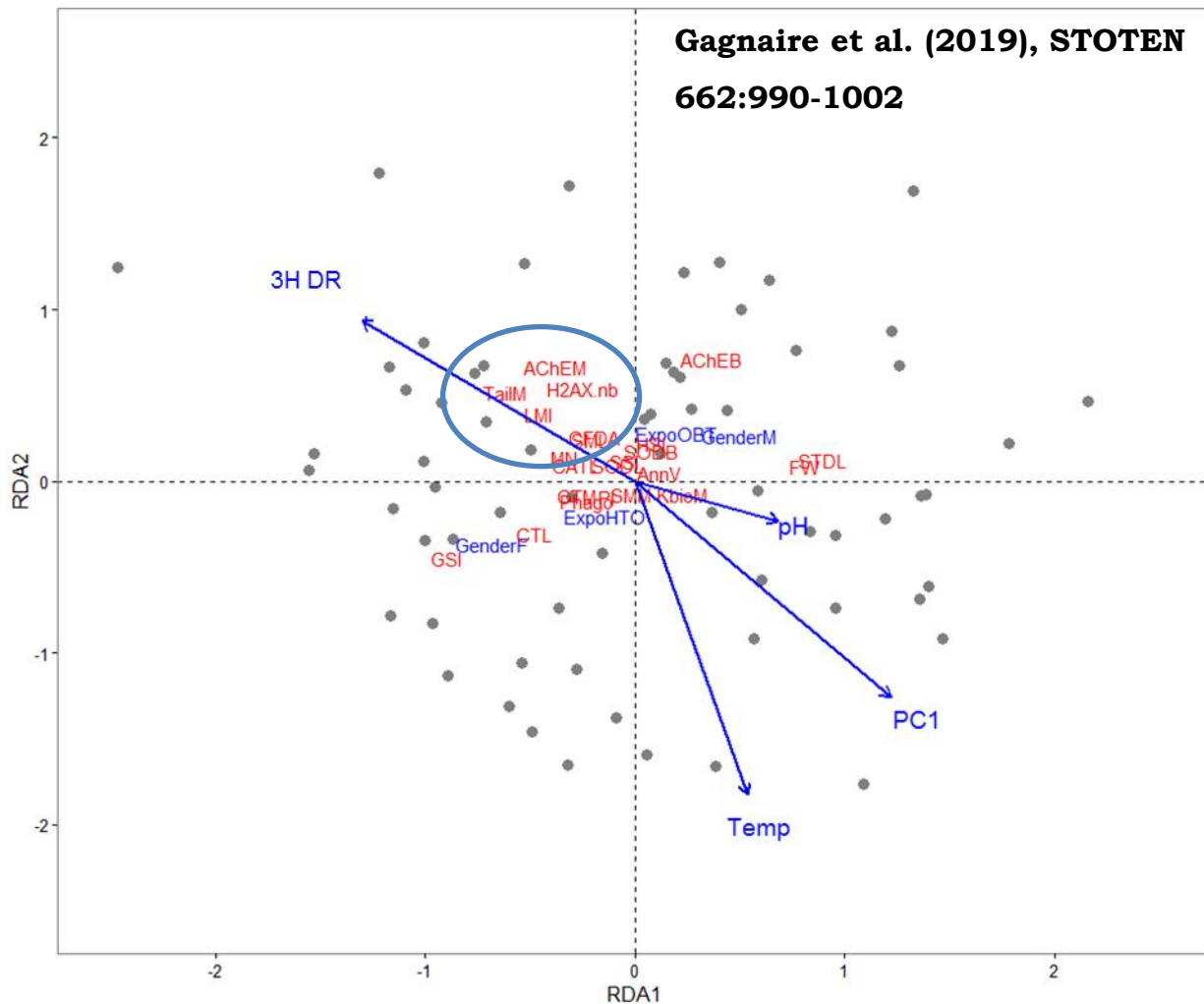

- Provides relevant (and direct) information on structure and/or function of communities/organisms

- However, results interpretation is not straightforward:
 - how to identify the contribution of stressors?
presented examples (former U mines, 3H contamination):
ionizing radiation may not be the main stressor

 - How to link changes (diversity, biomarkers...) with ecological consequences?

How to go beyond a descriptive approach?



- Exposure in ecosystems:
 - Chemical speciation?
 - Bioavailability?
- Protection target for ecological risk assessment:
 - Relevancy of the SSD?
- Ecotoxicity of substances in mixture:
 - CA or IA?
 - Interactions between substances?

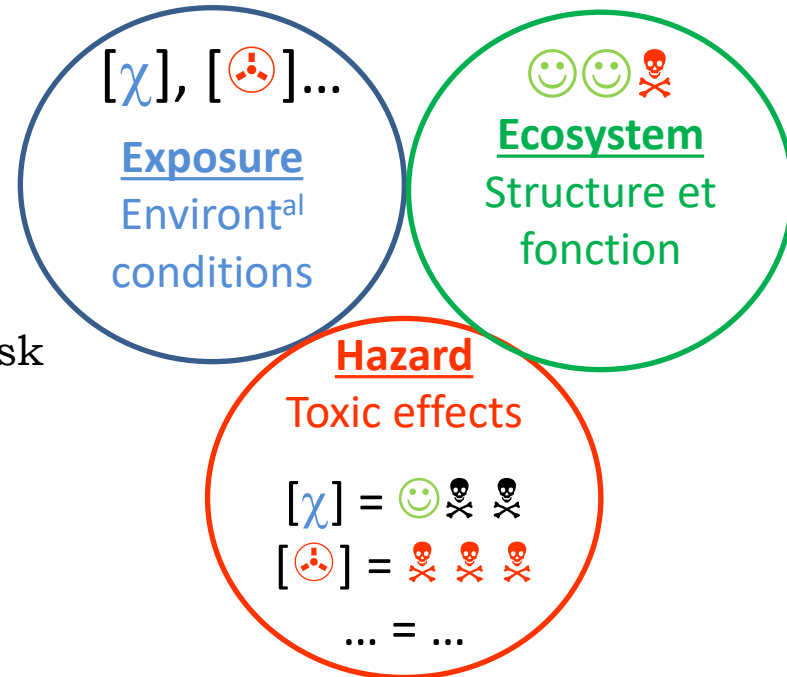

4- Beyond a descriptive approach

Exposure : Speciation and Bioavailability

Tipping & Lofst (2013) Aquat Tox 142-3:114

- Generalization of BLM approach : WHAM-FTOX
- metal-organism binding on non-specific sites; analogy with humic acids (WHAM)
- Advantage: model already parameterized and thermodynamically coherent

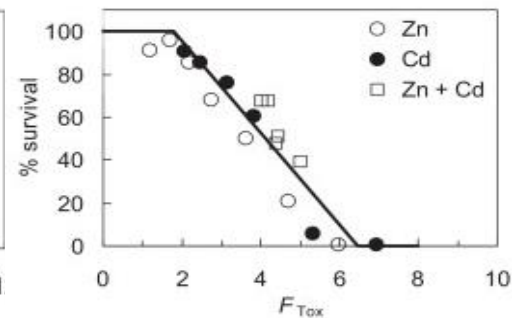
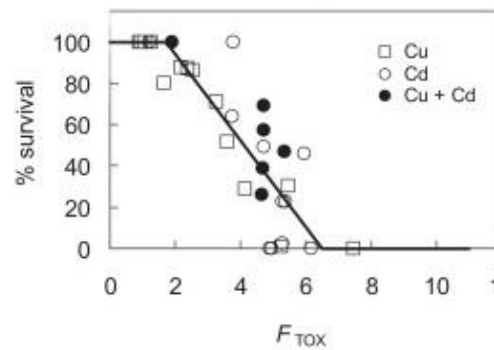
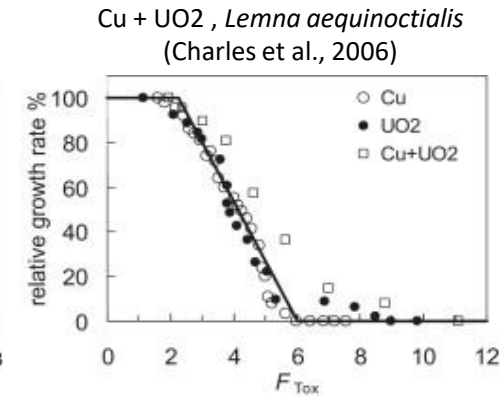
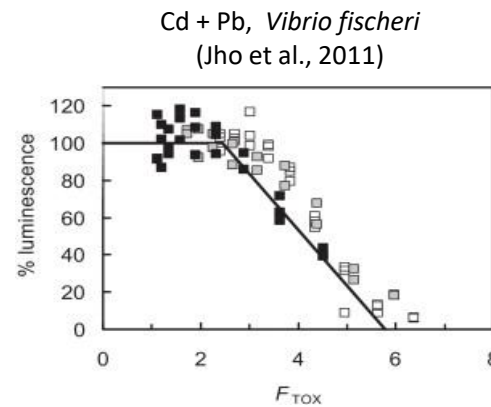

Toxic Function:

$$F_{TOX} = \sum \alpha_M v_m$$

α_M : quantité de métal M accumulé ($mmol.g^{-1}$)

v_M : coefficient de toxicité

Toxic Response:

$$TR = \frac{F_{TOX} - F_{TOX,LT}}{F_{TOX,UT} - F_{TOX,LT}}$$

$F_{TOX,LT}$: lower threshold (pas d'effet)

$F_{TOX,UT}$: upper threshold (effet maximum)

4- Beyond a descriptive approach

SSD and msPAF: Integrated Approach for Ecological Risk Assessment

- Prediction of effects from laboratory data base (SSD)
 - Measurement of the contamination pressure (Cd, Cu, Pb, Ni, Zn, ammonium, triclosan, ...)
 - Bioavailability (available fraction, hardness correction)
- Mixed mixture model (CA ou IA)
- Fish species diversity (espèces de poissons, 700 sites, Ohio)
- msPAF vs. species abundance correlation (GLM)

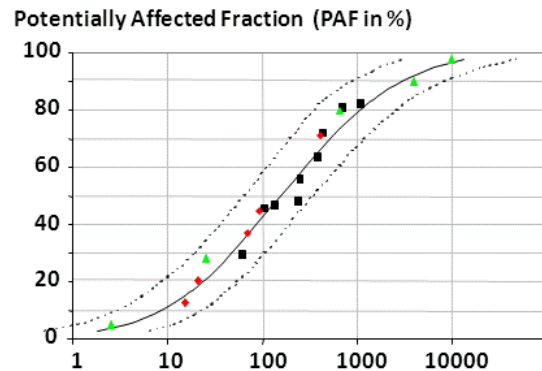

Posthuma & de Zwart (2006) ET&C 25:1105

Ra et al. (2006) ET&C 25:2107

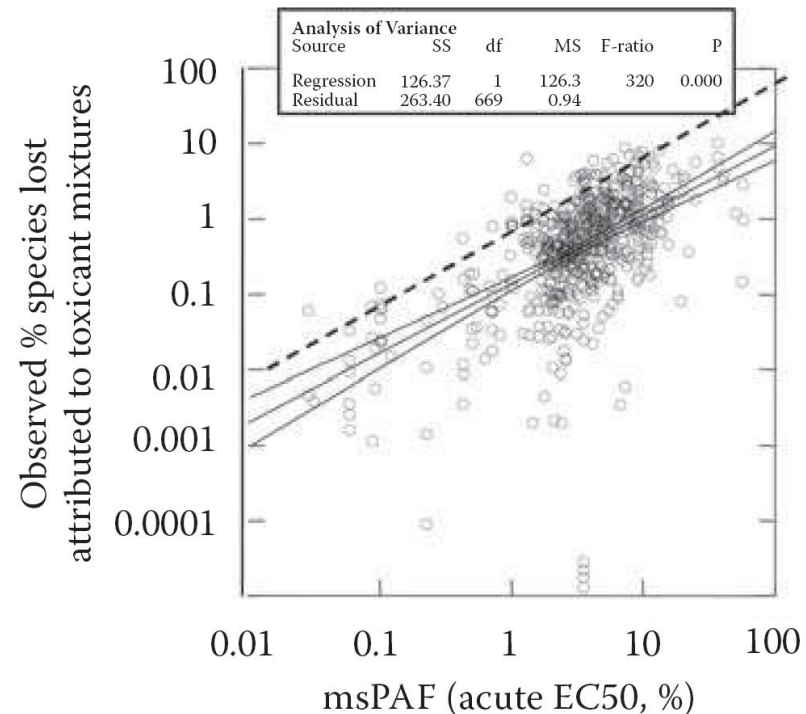
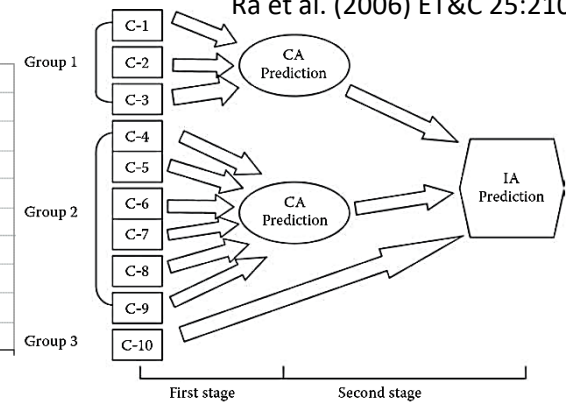

4- Beyond a descriptive approach

Ecotoxicity: Interactions between stable and radioactive substances

- 16 reported studies (binary mixtures, 11 organisms)
- 13 Negative Interactions
 - U + Se, Cd
 - γ + Cd, Pb, Al
- 10 Positive Interactions
 - β + Cu
 - γ + Cd, Hg
 - γ + organiques
 - Pu + γ , Amiante, Be
- Exploratory studies (partial experimental design: doses, ratios, effect types considered)
- Not very informative about the mechanisms (toxicico-kinetic and toxic-dynamic interaction)

from Vanhoudt *et al.* (2012) *Env Poll* 168:177

	RN	Ch.	-	=	+	
U + métaux/métalloïdes						
<i>Lemna aequinoctialis</i>	U	Cu	X			Charles <i>et al.</i> (2006)
<i>Arabidopsis thaliana</i>	U	Cd			X	Vanhoudt <i>et al.</i> (2010)
<i>Caenorhabditis elegans</i>	U	Cd	X			Margerit <i>et al.</i> (in prep)
<i>Daphnia magna</i>	U	Se	X			Zeman <i>et al.</i> (2007)
Rayonnement + métaux						
<i>Chlamydomonas reinhardtii</i>	H-3	Cu			X	Réty <i>et al.</i> (2012)
<i>Hordeum vulgare</i>	Cs-137	Cd	X	X	X	Geras'kin <i>et al.</i> (2005)
<i>Souris</i>	X-ray	Cd	X		X	Michel & Fritz-Niggli (1986)
<i>Salmo salar</i>	Gamma-rays	Cd			X	Mothersill <i>et al.</i> (2007)
<i>Salmo salar</i>	Co-60	Cd	X			Salbu <i>et al.</i> (2008)
<i>Salmo salar</i>	Co-60	Cd	X			Olsvik <i>et al.</i> (2010)
<i>Oryzias latipes</i>	Cs-137	Cd			X	Shimada <i>et al.</i> (1985)
<i>Souris</i>	X-ray	Cd	X			Michel & Balla (1987)
<i>Hordeum vulgare</i>	Cs-137	Pb	X	X		Geras'kin <i>et al.</i> (2005)
<i>Salmo salar</i>	Gamma-rays	Al			X	Mothersill <i>et al.</i> (2007)
<i>Salmo salar</i>	Co-60	Al			X	Salbu <i>et al.</i> (2008)
<i>Salmo salar</i>	Co-60	Al	X			Olsvik <i>et al.</i> (2010)
<i>Oryzias latipes</i>	Cs-137	As			X	Shimada <i>et al.</i> (1985)
<i>Souris</i>	X-ray	Hg			X	Michel & Balla (1987)
Rayonnement + organiques						
<i>Hordeum vulgare</i>	Cs-137	2,4-D	X	X		Geras'kin <i>et al.</i> (2005)
<i>Tradescantia</i>	X-ray	PDA	X		X	Xiao & Ichikawa (1998)
<i>Tradescantia</i>	X-ray	DMN	X	X	X	Xiao & Ichikawa (1998)
<i>Oryzias latipes</i>	Cs-137	Cycloheximide			X	Shimada <i>et al.</i> (1985)
Pu en mélange						
<i>Rat</i>	X-ray	Pu-239		X	X	Ballou <i>et al.</i> (1962)
<i>Rat</i>	Pu-239	Amiante		X		Sanders (1975)
<i>Rat</i>	Pu-239	Be			X	Finch <i>et al.</i> (1991)

4- Beyond a descriptive approach

Ecotoxicity: Interactions between stable and radioactive substances

Conclusions from WP4 (2015)

STRATEGY FOR ALLIED RADIOECOLOGY

- **general pattern of the combined effects of $^{238}\text{UxCd}$ and $^{137}\text{mCsCd}$ across species**
→ needed to examine a wide a range of endpoints, timepoints and exposure conditions (bioavailability, bioaccumulation)

→ consistent with the use of SSDs derivations?

- **some interactions were explained (mainly antagonistic) by bioavailability and toxicokinetics (rarely toxicodynamic processes)**
→ needs robust exposure characterization (speciation, bioavailability & bioacc.)
→ toxicokinetic/dynamics (eg. DEBtox) helps for an overall conclusion

→ no evidence of large (but some) synergism: additivity assumption sufficient?

- **we used huge, but mainly 'bioassay-derived' experimental designs**
→ robust but low sensitive species, endpoints, timepoints (=high exposure needed)
- **need more ecological and biological realism to identify interactions!**

→ interactions & mode of action at cell/molecular level?

→ interactions at low doses and effect?

→ interactions at higher level (populations) and long-term (trans-generational)?

4- Beyond a descriptive approach

Ecotoxicity: Interactions between stable and radioactive substances

DEBtox: Toxicokinetic & dynamic model

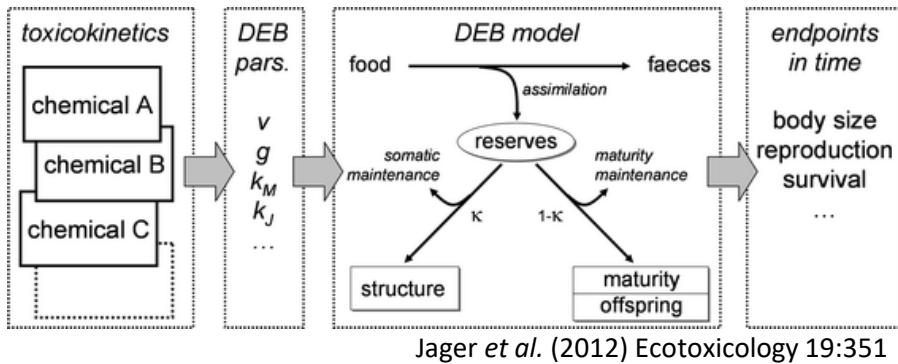

- antagonism: at toxicokinetic or toxicodynamic level?

Measured data

● Cd

- explained by an interaction in the media ($\downarrow [Cd]_{available}$ with U)

DEBtox prediction

Synergism

→ overall conclusion (timepoints, endpoints) = additivity (slight synergism at low effect)

Antagonism

ex. Toxicity of U+Cd to *C. elegans*

DEBtox of individual substance (U and Cd) + use of additivity model (ex. IA, 11-day)

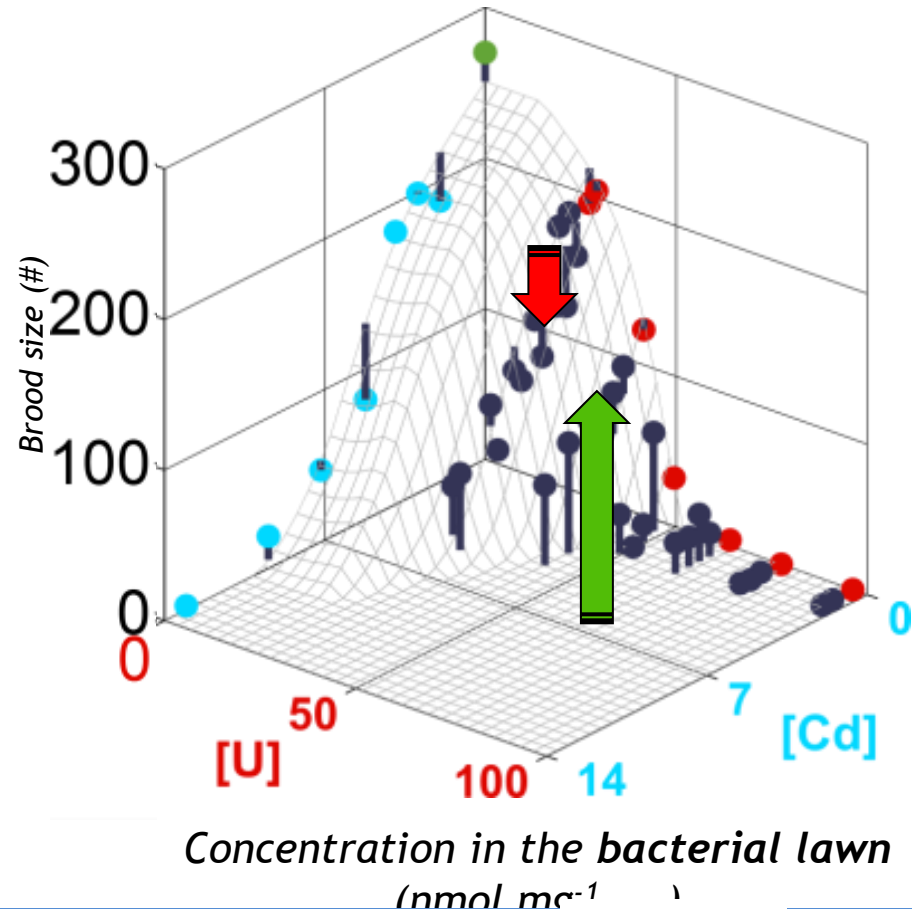

4- Beyond a descriptive approach

Strong potential of AOP approaches

'Extension' of the DEBtox approach

➔ From linear AOPs to AOP networks

Usefulness :

- **Low doses:** undetectable individual exposure / effect levels. combined exposure with detectable answers
- Identification of the **main risk factors** in the exposome
- **Cause and effect relationships:** Similar AOs may be triggered by different MIEs (affect jointly the same KE)
limitation: complex interactions (eg, complex role of low-dose mixtures in carcinogenesis) - Goodson et al., 2015)

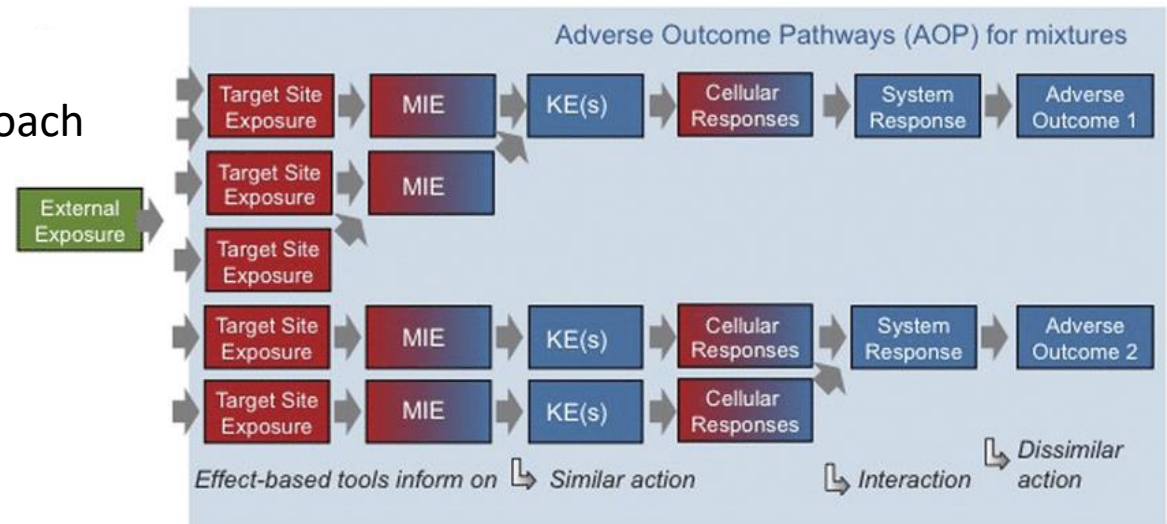

Escher et al. (2017)

Conclusion / Take home message (1/3)

- **Ecosystem Exposure**

- Generalization of the BLM approach to consider interactions in the medium (speciation) and bioavailability (eg WHAM-Ftox)

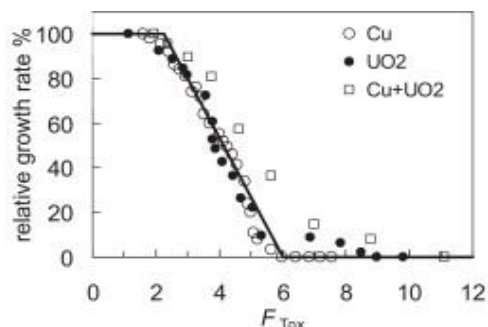

Tipping & Lofst (2013) Aquat Tox 142-3:114

- Co-exposure with organic substances?
- integration of other stress factors (temperature, biotope changes, UVs...)?

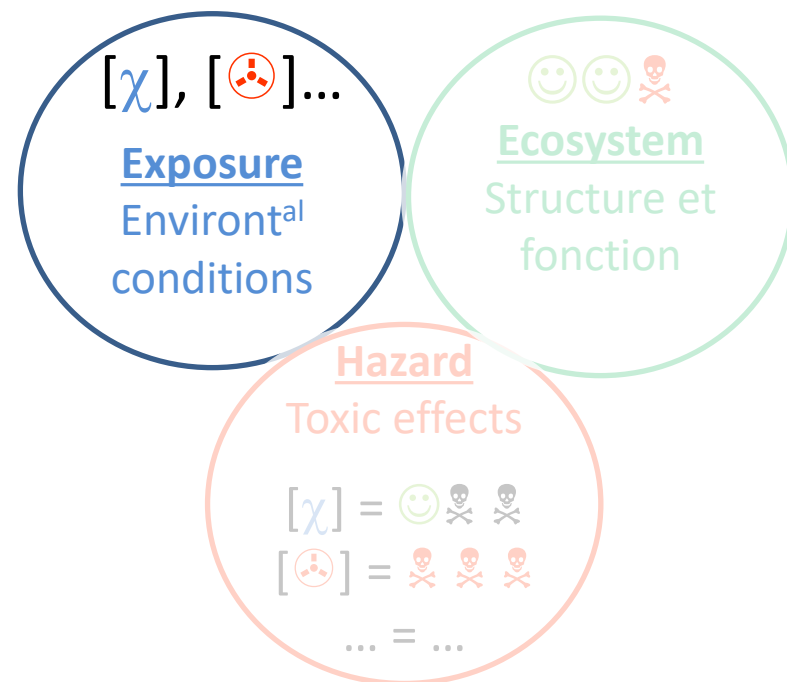

Conclusion / Take home message (2/3)

- **Ecotoxicity**

- Explicit modeling coupling toxicokinetic and dynamic (eg DEBtox, AOP) to generalize the observations (mixtures, species, exposure)

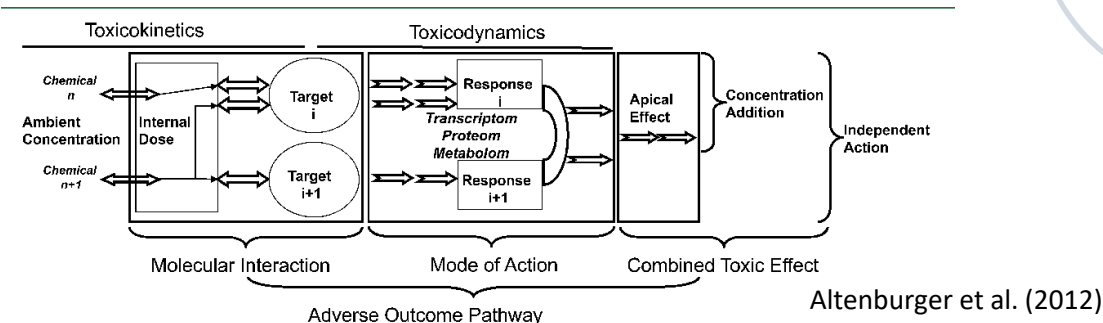
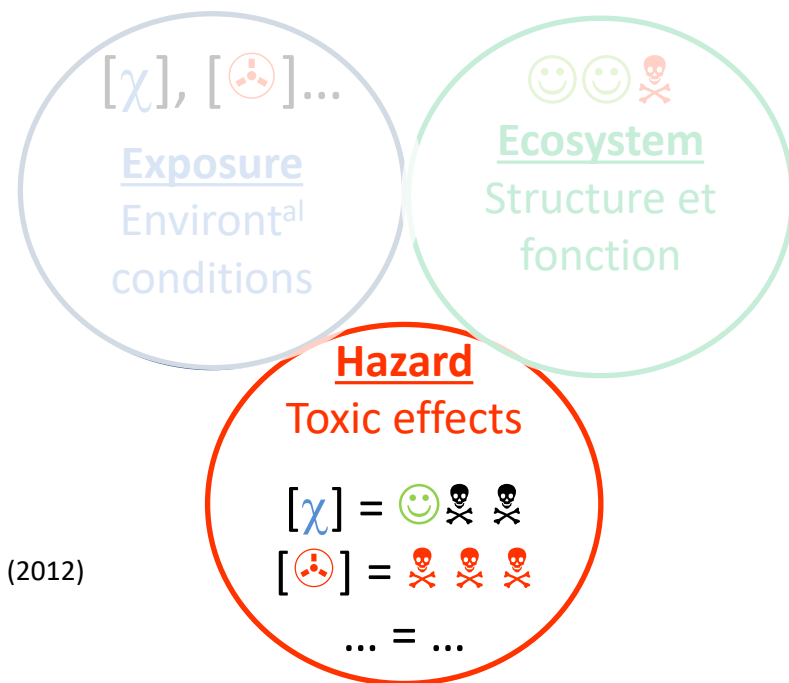

- **Experimental evidences of interactions**

Synergisms and/or Antagonisms may be explained (at least partially) with mechanistic approaches

interactions at different steps from exposure, initial events up to Adverse Outcomes

Conclusion / Take home message (3/3)

- **Ecological Risk Analysis** needs a better prognostic power.
 - May be (partly) solved by a **proper exposure characterisation** (eg. taking into account bioavailability,... exposome) and description of *interactions* (TDTK models such as DEBtox; AOP)
 - **msPAF** (based on SSD) seems to be satisfactory to describe the response of communities, by taking into account bioavailability, modes of action (CA / IA) and lack of specific interaction
 - However, the **real ecological status** under mixture stress **needs more field survey** of ecologically-relevant endpoints (communities structure and function)

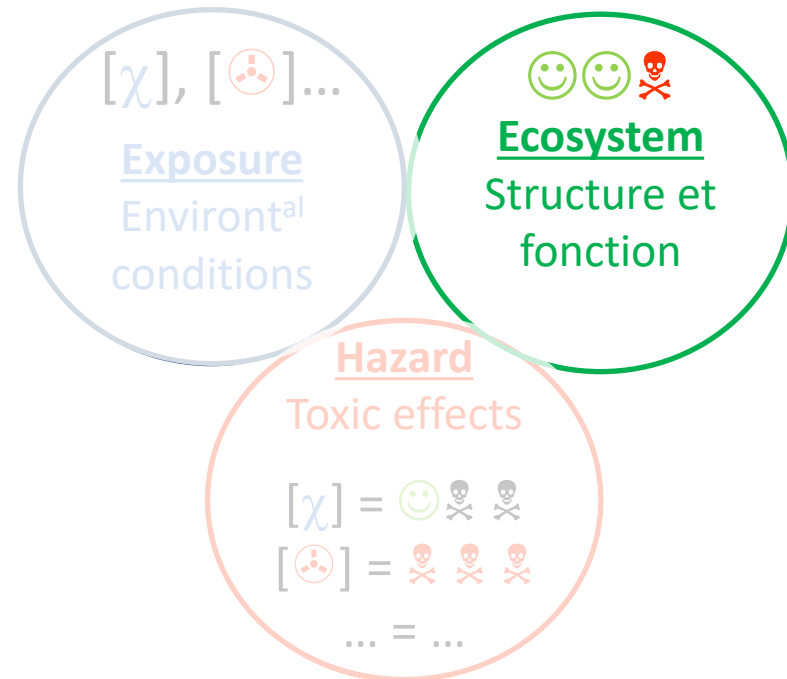

Combined exposures to stable and radioactive substances for ecological risk assessment

Rodolphe GILBIN, Laureline FÉVRIER, Catherine LECOMTE, Frédéric ALONZO, Béatrice GAGNAIRE, Jean-Marc BONZOM, Olivier ARMANT, Karine BEAUGELIN, Hugo LEPAGE, Jacqueline GARNIER-LAPLACE

Rodolphe GILBIN

rodolphe.gilbin@irsn.fr

**Research Department on Transfers and Effects of
Radionuclides on ecosystems
IRSN / PSE-ENV / SRTE
Cadarache, France**

