



HAL
open science

Core coolability in loss of coolant accident: the PERFROI project

Georges Repetto, Philippe March, Christophe Marquié, Nicolas Waekel,
Marie-Christine Baietto, Michel Gradeck

► To cite this version:

Georges Repetto, Philippe March, Christophe Marquié, Nicolas Waekel, Marie-Christine Baietto, et al.. Core coolability in loss of coolant accident: the PERFROI project. Top Fuel 14, American Nuclear Society, Sep 2014, Sendai (Japan), Japan. irsn-04474876

HAL Id: irsn-04474876

<https://irsn.hal.science/irsn-04474876v1>

Submitted on 23 Feb 2024

HAL is a multi-disciplinary open access archive for the deposit and dissemination of scientific research documents, whether they are published or not. The documents may come from teaching and research institutions in France or abroad, or from public or private research centers.

L'archive ouverte pluridisciplinaire **HAL**, est destinée au dépôt et à la diffusion de documents scientifiques de niveau recherche, publiés ou non, émanant des établissements d'enseignement et de recherche français ou étrangers, des laboratoires publics ou privés.

Copyright

Core coolability in loss of coolant accident: the PERFROI project

G. Repetto *, Ph. March, Ch. Marquié, N. Trégourés ¹, Nicolas Waeckel ², Marie-christine Baidetto ³, and Michel Gradeck ⁴

¹ Institut de Radioprotection et de Sûreté Nucléaire, Cadarache, Saint Paul lez Durance, 13115- BP3, France

Tel. +33-442-19 96 73, E-mail: georges.repetto@irsn.fr

² EDF - Electricité de France, SEPTEN, Villeurbanne, France

³ LaMCoS - Mechanics Laboratory Contact and Structures - INSA Lyon, France

⁴ LEMTA-CNRS, Nancy, University of Lorraine, France

ABSTRACT: The Fukushima accident has pointed out the importance of considering all possible strategies to ensure the cooling of a nuclear reactor core in accidental conditions. Maintaining the fuel coolability would avoid a further meltdown that may cause a rupture of the reactor vessel, significant radioactive releases to the containment of the reactor and, beyond, to the environment. An accident can cause the loss of cooling of the reactor core: a partial or even complete drying of the fuel assemblies may occur. In these conditions, increase of fuel temperature and pressure drop in the reactor core may lead to significant deformation or rupture of the fuel rod cladding, disperse the fragmented fuel and release fission products in the primary circuit. The consequences of cladding deformations on the cooling efficiency when reflooding the core by safety systems are an important safety issue.

IRSN conducted a comprehensive assessment on numerous R&D programs performed during the last thirty years, in particular on swelling and rupture of the fuel rod cladding, the impact of this swelling on the cooling of fuel assemblies, the oxidation and the strength of the cladding during the quenching and during the subsequent handling (physical remove or extraction of the fuel assembly out of the core). These studies have led to significant progress in the understanding of these mechanisms; however there are still some pending questions. An R&D program has been launched by IRSN with the support of EDF, including both LOCA experimentation and mathematical modeling. The PERFROI project, planned from 2014 to 2019, is supported by the French government, within the framework of the “investment for the future” (PIA) initiative, under the umbrella of the French National Research Agency (ANR). It focuses on the main issues related to the mechanical behavior and the coolability of a partially deformed fuel assembly. Its outcomes will be beneficial to nuclear safety at the international level.

KEYWORDS: Coolability, blockage, LOCA, cladding deformation, rupture, fuel relocation.

I. INTRODUCTION AND CONTEXT THE PROJECT

During an accident causing the loss of the coolant of the primary circuit (LOCA), partial or even complete drying of the fuel assemblies may occur. In these conditions, of the fuel temperature increase and the coolant pressure drop in the reactor core may lead to significant deformation or rupture of the fuel rod cladding. Depending on the burnup of the fuel rod, extensive fuel fragmentation may occur, leading to fuel relocation within the ballooned area and possibly leading to limited fuel particles dispersal into the coolant through the ruptured cladding. Depending on the size and the distribution of the ballooned areas within the fuel bundle, the cooling flow might be impaired, which may challenge the fuel assembly coolability and, by extension, the core coolability.

The results ² (Fig.1), which illustrate this phenomenon, come from an experimental LOCA program performed, in the 1980's by the Institut de Protection et de Sûreté Nucléaire former IRSN, in 5x5 bundle including fresh fuel rods. Different LOCA experiments performed with irradiated fuel rods respectively 35 GWd/t in FR2-Germany ¹⁴. (Fig.2a) and 90 GWd/t, more recently in Halden- Norway ¹⁷ (Fig.2b), have shown an accumulation of the fragmented fuel pellets in the ballooned region. The resulting increase of the power density in the ballooned area may also affect the core coolability.

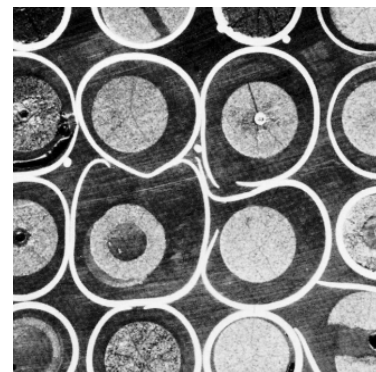
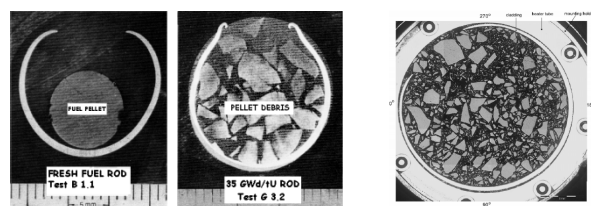

Fig. 1: Bundle of deformed fuel rod Phebus LOCA experiments (1983)



a) FR2 Fuel rods fresh or irradiated b) Halden test

Fig. 2: Fuel relocation in the ballooned area

The consequences of deformations and fuel relocation on the cooling efficiency when reflooding the core by the ECCS (emergency core cooling systems) are an important safety issue.

The proposed research program is based on a state of the art review of the available experimental results. It aims also at providing answers to the first feedback from the Fukushima accident released by IRSN: "Fukushima, one year after: First analysis of the accident and its consequences," Report IRSN/DG/2012-001 of 12 March 2012¹, which clearly highlights "that there were still large uncertainties on some related phenomena conducting to a meltdown of the core".

Research areas include in-depth analysis of how the accident is progressing as well as targeted research on the most apparent gaps: thermal hydraulic and thermal mechanical behavior of fuel assemblies linked to the loss of cooling efficiency, the effect of emergency cooling after effective partial melting, the risks of criticality, the hydrogen production during the cooling period and the associated risk of potential explosions, the transient behavior of the molten core or debris in the bottom of the reactor vessel, and the reduction of radioactive releases out of the containment. In this context, IRSN considers that it must pursue experimental research programs on reactivity excursion or loss of cooling issues. The knowledge generated by this new project will answer long shared concerns by the international community (such as the effect of fuel relocation in blocked areas in the core), and will allow to validate the French modeling code used by IRSN and EDF to simulate any prototypical LOCA transient.

From a regulatory point of view, maintaining long term core coolability is the primary requirement. More specifically, to fulfill this requirement, two criteria (called decoupling criteria), which are calculable and representative of the expected physical phenomena related parameters, are used: the Equivalent Cladding Reacted (ECR) and the maximum temperature of the cladding. The regulations require these two values (ECR : 17%, and Tmax : 1204°C) that should not be exceeded during a prototypical LOCA transient. Compliance with these criteria is obtained through adapted methodologies and advanced simulation tools (carefully validated on specific experimental results).

As in other countries, LOCA rulemaking changes have been initiated in France to account for recent experimental results (impact of burnup on the LOCA limits, effect of fuel relocation on the peak cladding temperature, etc..) and to account for the fact that the current (advanced) fuels are irradiated in more challenging operating conditions than in the 1970's when the former LOCA limits had been defined..

IRSN has produced a state of the art review of the R&D programs conducted during the last thirty years, especially the swelling and the rupture of the cladding², the impact of the fuel deformation on the cooling of fuel assemblies³, the oxidation/hydriding and the mechanical resistance of the cladding during quench and post-quench loads⁴. This synthesis, which is now an international reference (it is considered as a reference document by the U.S. NRC - Nuclear Regulatory Commission of the United States and is the basis of the State Of the Art Report (SOAR LOCA) OECD/CSNI⁵), showed the need to upgrade the safety

standards, and identified three important issues (or pending questions) that must be addressed:

- What is the maximum rate of blockage that can result in during a LOCA and is the core still coolable with such a flow blockage?
- When and how the fuel fragments relocate in the ballooned areas? What is the impact of fuel relocation on the peak cladding temperature (PCT) and on the maximum oxidation rate? What would be the potential impact of the fuel dispersion in the coolant?
- During and after the reflooding of the core, how to demonstrate long term coolability, taking into account base irradiation, transient oxidation and hydrogen pick up? What radial or axial forces should be applied to a fuel rod during the quenching phase to assess its mechanical strength?

An R&D program (CYCLADES⁶) was launched by IRSN with the support of EDF to provide answers to these three questions. This program includes both experimental activities and software development for calculation (namely DRACCAR^{7,8,9} and DIFFOX codes¹⁰). It takes into account the findings of the French Standing Group (called "Groupe Permanent") on Nuclear Pressurized Water Reactor held in 2010, in particular on the physical phenomena, the long-term core coolability, and the transition breaks configuration.

The PERFROI project proposed to answer the first question above. In scientific terms, the project aims firstly to quantify the thermal mechanical evolution of cladding in some specific configurations such as those involving contact between fuel rods or significant temperature gradients in the fuel rod environment, and to quantify the impact of fragmented fuel rods relocation in the balloon on cooling of the fuel assemblies. Specific research aims to study heat exchanges occurring between the walls of the deformed cladding and the two-phase flow in fog form (i.e. steam plus droplets); these heat exchanges conditioning temperature change in a fuel assembly. Antagonist influences due to the presence of a blockage will be evaluated. These influences result from the following physical phenomena:

- The flow bypass of the blocked region, due to the reduction of the section between the deformed fuel rods, leading to a reduction of mass flow in the sub channels of the blockage. This reduction limits the flow of the cooling capacity.
- The presence of water droplets in the steam flow may modify this trend. Their role in heat transfer is important, whether through the heat extracted at their impact on the walls¹¹ or via their vaporization in the bulk flow. Due to their inertia, their paths do not necessarily follow that of the steam flow path.

II. COOLABILITY OF BLOCKED REGION WITH FUEL RELOCATION

The domestic and international state of the art describing the context and the need of coolability of blocked regions is synthesized in some IRSN publications^{12,13}.

The main lessons are summarized below. Based on the previous experimental programs discussed in the IRSN literature reviews ^{2,3}, the experimental conditions, including the characteristics of the blockage (blockage rate, length of the maximum blocked area, cladding thickness in the ballooned zone, ...) and the initial thermal hydraulic test conditions, the phenomena listed below have been ranked accordingly to their impact level:

1. Representativity of the blockage
2. Influence of the blockage rate,
3. Influence of the length of the blockage,
4. Influence of the blockage configuration: coplanar versus non-coplanar
5. Influence of the flow bypass
6. Influence of the nature of the reflooding: forced versus gravity.

The analysis of these phenomena can specify limits of the blockage coolability in the most penalized geometry (length and rate) and thermal hydraulic conditions. Thus, it seems that the blockages although important, if of moderate length (<10 cm), pose no significant cooling impairment, as one might be tempted to conclude in view of only FEBA ¹⁵ and SEFLEX ¹⁶ results, a 90% blocking is always coolable. It was also shown that the maximum rate of 90% blockage is not necessarily the most case penalizing the cooling if the deformation is axially extended.

It also follows, from this analysis ³, that the understanding of the deformation and rupture mechanisms of the fuel cladding is a fundamental concern: in fact, the deformation and swelling of the claddings are causing the blockage of sub-channels, and cladding rupture freezes this deformation balancing the internal and external pressures of the fuel rod. Therefore, it is first necessary to understand the mechanisms of deformation and fracture (thermal mechanical behavior) to investigate realistically the effects of the blockage on the thermal hydraulic.

This bibliography study also highlighted a particular concern. All the experimental results and the main outcomes regarding cooling of partially blocked assemblies were obtained on out-of-pile tests using bundles with electrically heated "fuel" rods.

Since the heating axial profiles of the simulators were uniform and preset, the tests didn't reproduce the impact the fuel relocation in the ballooned areas as observed in the in-pile tests performed on irradiated fuel rods (FR2 ¹⁴, PBF-LOC, ANL-ICL tests, including Halden IFA-650.4 test - Fig 2b) ¹⁷. The fuel fragments relocation results in a local increase of the power density depending on the filling ratio. However, the significant difference between test results comparable to FEBA ¹⁵ and SEFLEX ¹⁶ programs suggests a strong coupling between the heat source and the deformed claddings, as it may exist in a balloon filled with fragmented relocated fuel; this may significantly deteriorate the cooling of blocked regions.

Fuel relocation, as observed in several in-pile LOCA tests with irradiated fuel (listed above), and its potential impact on the local cooling of the blocked areas, have to be investigated and properly modeled.

III. DESCRIPTION OF THE PERFROI PROJECT

As the need for further studies on two thematic has been shown above, the PERFROI project has been structured in two axes:

1. Axis 1: thermal mechanical studies of the deformation and failure of fuel rods in LOCA conditions taking into account the effect of contact between rods and the effect of an azimuthal temperature gradient. The models or correlations describing the creep laws and rupture criteria from the results of these tests, will be integrated in the DRACCAR software, for the assessment of the fuel assembly deformation; a collaboration with the "LaMCoS" research laboratory (university of Lyon) will focus on analysis of the hydrogen behavior in cladding alloys and its impact on the mechanical behavior of the fuel rod.

The works that will be achieved in this axis are:

- Perform thermal mechanical creep and rupture tests. The main objective of these parametric tests (ELFE program) is to assess the thermal mechanical properties of the cladding which will be used in the COCAGNE tests program (see below);
 - Investigate the thermal mechanical swelling of cladding tubes in multi-rods configuration (COCAGNE test program). This multi-rods configuration has been little or even never studied experimentally up to now. These bundle tests will provide us new insights regarding balloons formation before and after contact between adjacent rods. It will also quantify the effect of azimuthal temperature gradients;
 - Validate models against the results of these tests,
 - Define a cladding creep rupture criterion valid for multi-rods conditions (to be implemented in the DRACCAR code).
2. Axis 2: study the thermal hydraulic behavior of a partially blocked core zone during the reflooding phase. Thermal hydraulic experiments will be performed in an out-of pile loop (COAL tests program), including a bundle of electrical rods whose deformed areas are locally overheated to simulate the fuel fragments relocation. The results of these experiments will help to refine and validate the heat exchange models used in DRACCAR multi-physics code during the reflooding phases. More detailed activities on thermal hydraulic foreseen in collaboration with the LEMTA research laboratory (university of Lorraine) will focus on the characterization of two phase flows with heat transfer in deformed structures.

1. ELFE experiments

The ELFE HT experiments are performed in the facility (Fig. 3a) which has been developed in 2013 to perform experiments at high temperature up to 1000°C.

Those separate effect experiments will be carried on 10 cm long samples (Fig. 3b). Different zirconium alloys will be tested with different initial conditions (as-received, pre-hydrided and pre-oxidized).

These experiments will be carried out in a wide temperature range (600°C - 1000°C).

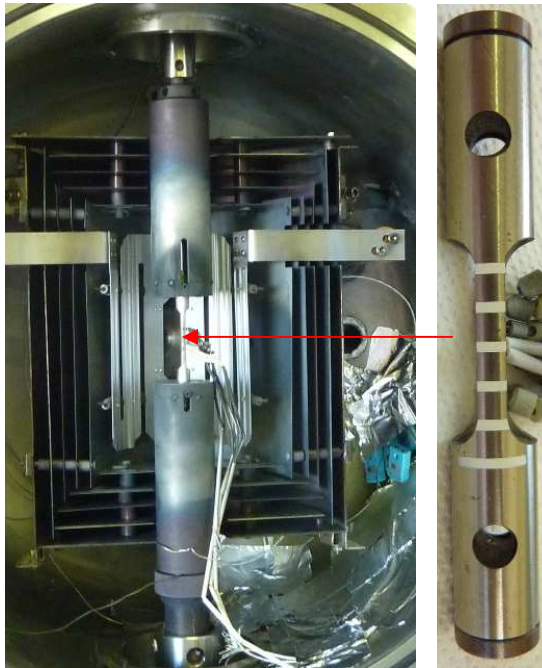

Fig. 3: a) ELFE facility and b) sample

The experimental results (tensile tests on test-tubes of simple geometry) will make it possible to obtain the creep laws and the rupture criteria for different cladding materials, useful for DRACCAR code input, but also to interpret the results of the upcoming COCAGNE experiments.

Prior to the experimental program, qualification of the ELFE facility has been performed by the end of 2013. The tests carried out until 825°C, show a very good repeatability and are in very good agreement with the values measured and given in the literature¹⁸ (Fig 4, point in red, green, blue). Some unexpected results were nevertheless obtained for the highest temperatures (1000 and 1030°C) and are still under investigation.

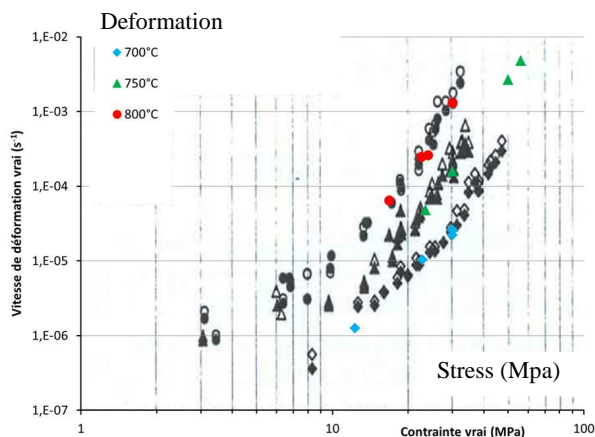

Fig. 4: results of the preliminary ELFE qualification tests

The experimental program is foreseen to be performed in 2014 and 2015 for Zircaloy-4 and above 2016/2017 for others cladding materials (M5TM or ZirloTM).

2. COCAGNE experiments

The objective of these experiments (second part of the thermal mechanical axis) is the study of the deformation of the fuel cladding in LOCA conditions and in a representative environment taking into account possible contact between neighbor fuel rods. In the principle, the cladding tube is pressurized and heated (direct resistive heating). It will then balloon and start making contact with 4 adjacent heated tubes (direct or indirect resistive heating), in an inerted environment, to avoid zirconium oxidation, for technical and safety reasons)

Before performing the experimental program (2016-2018), it is necessary to design and build a specific test device (Fig. 5a). The construction and the commissioning tests of the COCAGNE test facility are foreseen to be completed by the end of 2015.

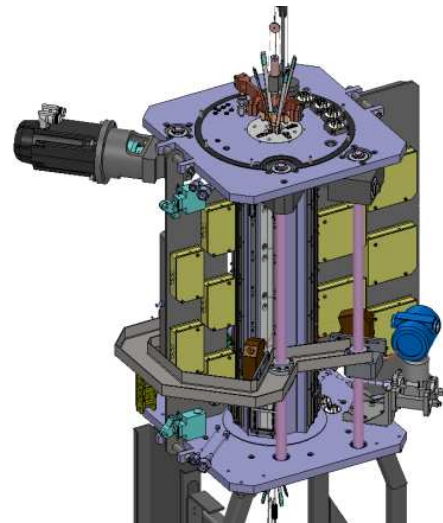

Fig. 5a: design of the COCAGNE facility

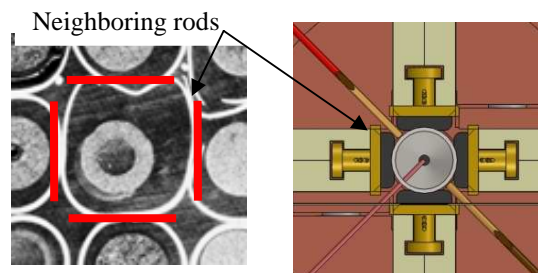

Fig. 5b: design of the test section

The COCAGNE test rods will be 60 cm long. The central rod will be pressurized (internal pressure can reach 250bar) during the heat-up with external pressure at 1 bar. The position and the geometry of the peripheral rods (Fig. 5b) have been defined to simulate as accurately as possible the contact related to mechanical and thermal phenomena. It will be possible to simulate a thermal gradient, and also to predict the presence of a guide tube in place of the surrounding tubes.

Two types of temperature tests are foreseen: isothermal tests between 600 and 1100°C and ramp tests up to 20K/s. The heating is performed by a direct Joule effect in an inert atmosphere.

Particular attention is paid to the development of the instrumentation of these tests:

- On-line measurement along three generating lines of the clad temperature with an uncertainty lower than 10°C,
- On-line measurement of radial deformation along the same three generating lines,
- On-line measurement of the internal pressure of the central fuel rod,
- Detection of the moment of the contact, its location and monitoring the development of the contact.

All these experimental results will allow improving and qualifying 3D thermal mechanical models, which are implemented in the DRACCAR software for numerical simulation of loss of coolant accident transients.

Special attention was brought to the design and the implementation of the instrumentation, especially the 3D deformation measurements and the contact detection between adjacent rods. COCAGNE aims to achieve non-intrusive measurements on a heated rod sample surrounded by a guard structure reproducing its thermal and geometric environment. To achieve the thermal homogeneity imposed on the sample ($\Delta T = 5$ to 10°C), the access slots for the instrumental referred has been maintain as thin as possible (about 2 mm).

The technological challenge is the following: precision on the measured temperatures should be close to $\pm 5^\circ\text{C}$ at 1000°C for ramps of about 20° C/s, on a length of 600 mm. This is not feasible with infrared standard pyrometers due to the sensitivity to the “guard” temperature and to the central deformation. To address this issue, IRSN has designed and qualified a moving platform to measure both temperature and deformation at high frequency, using laser telemetry sensors for deformation and UV-pyrometers, for the temperature. .

To achieve the aimed temperature ramps, only direct resistance heating should be convenient. This required characterization of the mechanical strength of the insulated layer provided on partial rods guard.

Defining the general and detailed designs of the installation have been completed, and the next steps are the choice of the subcontractors and the realization of the facility.

3. Specific research on cladding behavior

In the frame of the thermal mechanical axis 1, specific research at INSA Lyon (LaMCoS - Mechanics of Contact and Structures Laboratory) will focus on in-depth analysis of the hydrogen behavior in cladding alloys and its interaction with the fuel rod mechanical behavior¹⁹ through a PhD position (2014-2016).

This will especially characterize the phenomena associated with the mobility of hydrogen in the alloy under axial thermal mechanical loading (new feature): hydrogen has been recognized to modify the mechanical behavior of zirconium alloys fuel cladding: these are the effects known due to “hydriding”.

Experiments will be conducted using a dedicated experimental set up, updated from the LaMCoS –INSA Lyon facility²⁰. This facility (Fig. 6) was developed previously for characterizing the fracture kinetics of a vessel bottom head

during a core meltdown accident in a pressurized water reactor.

This set-up is able to perform bi-axial loading (compression and traction load) under controlled thermal loading up to 1200 °C using tubular specimens. The heating of the sample is provided by induction process and the temperature is controlled by thermocouples. The temperature map and deformation are respectively followed by different infrared and high-speed digital cameras.

Developments will be achieved on the new set-up to conduct experiments under thermal and mechanical loading characteristics of LOCA accident. Field measurements will be carried out continuously during the experiments.

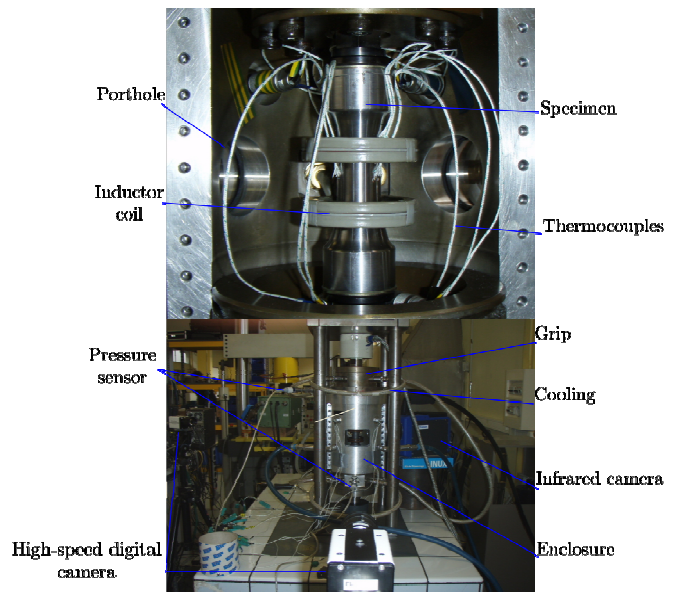

Fig. 6: LaMCoS- INSA Lyon facility

4. COAL experiments

The COAL sub-program will concern thermal hydraulic experiments on a bundle of non-irradiated rods, with simulation of partial blockage and fuel relocation. The bundle will consist of rods (electrically heated), some with pre-deformed zone with local overheating representing fuel relocation. The test bundle will be made of 49 (7x7) rods (including 16 deformed rods and 33 non deformed rods – Fig 7), similar to that of the THETIS^{21, 22} tests performed in the past by AEE Winfrith UK in 1983-1984, which will also allow experimental comparisons. The COAL bundle will include guide tubes (4) and spacers, to be as representative as possible of a real PWR fuel bundle.

This test section will be inserted in an out of pile thermal hydraulic loop which can simulate the reflooding phase of a prototypical LOCA transient.

The experimental parameters of the test campaigns will be defined in order to investigate the bundle geometry related phenomena (blockage ratio, balloons lengths) and the thermal hydraulic related phenomena (local overheating of the balloons, injected water temperature, coolant flow rate and system pressure levels and kinetics to simulate various break sizes).

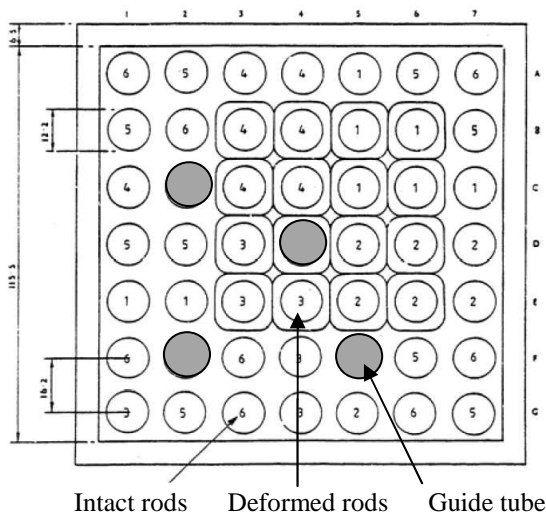

Fig. 7: typical bundle fuel rods for COAL experiments

The device is about 3,5 m height (real PWR geometry) and roughly 10 cm in diameter. The main thermal hydraulics parameters foreseen are in the range below:

- inlet water flow velocity : 1 to 8 cm/s,
- coolant pressure : 1 or 2 to 30 bar,
- inlet water sub cooling : 40 to 20°C.

Others parameters (flow blockage - ratio and length and power distribution) will be defined based on thermal hydraulic parametric studies.

The work will proceed as follows:

1. First of all, a commissioning test will be performed in 2016 on a bundle with non-deformed heated rods. This test will be used as a reference test.
2. Then tests with heated pre-deformed simulators, including local overheating of the balloon regions, will be performed from mid 2016 to 2018. Three series of tests are planned with different flow blockage ratios. In each series, the effects of thermal hydraulic parameters will be carefully investigated. The third campaign is optional and depends on the results of the previous campaigns.
3. Finally, all the tests will be analyzed and interpreted. The objective is to validate a heat transfer model adapted to bundle conditions, to be implemented in DRACCAR code¹⁰.

It should be noted that COAL is a program to be conducted in an existing ad-hoc thermal hydraulic facility, IRSN will only provide, the test section. Up to now, it is foreseen that these experiments will be conducted by AREVA under IRSN contract, in the BENSON facility (Erlangen in Germany), able to run high pressure tests up to 30 bar.

The main technical difficulties identified at this stage are related to the manufacturing of the test rods, including an adapted instrumentation operational at high temperature and high pressure (30 bar). The first step of this axis is to develop a prototype of the electrically heated test rod with a local overheated balloon (SAFRAN electrical rod (Fig. 8)).

SAFRAN is a real technological challenge, i.e. besides obtaining a representative tube geometry, the following constraints have been added: technique should allow extended test rods manufacturing at a reasonable cost, thermocouples to be welded on the outer surface of the cladding and the resistor should survive multiple cycles in corrosive steam above 1000°C and several quench phases.

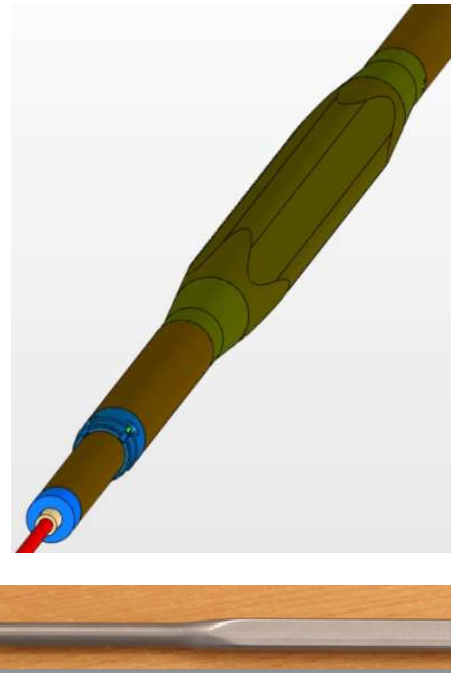

Fig. 8: electrical deformed fuel rod prototype (SAFRAN)

5. Specific research on thermal hydraulics

Within the frame of this thermal hydraulic axis, research is foreseen at the Laboratory for Energy, Theoretical and Applied Mechanics-LEMETA/CNRS-University of Lorraine.

It will focus on the characterization of two-phase flow with heat transfer in the deformed structures (Fig. 9).

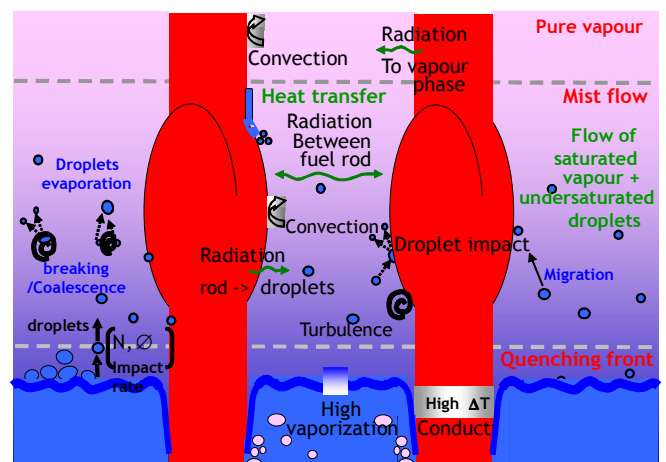

Fig. 9: local phenomena involved in the process

This will consist in performing specific separate effect tests at the sub-channel scale (channel between fluid and rods). The proposed approach is expected to validate the models already developed on flow and heat transfer between wall and fluid²³.

Realization and interpretation of these tests will be part of a PhD thesis (2016-2018). It is also planned to conduct a study of the so-called "quench front propagation" area with the aim to better model its dynamics, especially the generation of droplets. This will be done as part of a post-doctoral research project.

Local phenomena involved in the process²⁴ are illustrated in the Fig. 9. As it can be seen on the figure 9, the two-phase flow occurring in the ballooned region is a mist flow (water droplet + steam). In previous works^{11, 23, 24}, we developed a set-up to accurately measure the heat transfer between a single droplet and a hot wall for conditions close to LOCA.

As the interaction between the droplets and the wall is very short ($\sim 10^{-4}$ s for the droplet size of interest) and the exchanged heat fluxes very small (a few mW), we designed an experimental test device to measure the heat transfer during the resident time and also developed a specific inverse conduction measurement technique to estimate heat flux at the wall^{11, 23}, from temperature measurements (Fig. 10).

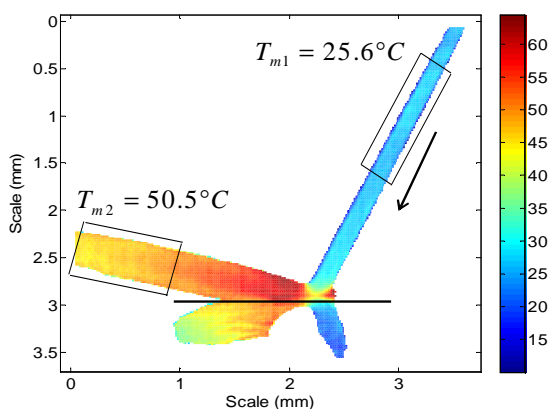

Fig. 10: Temperature measurement

The experiments in ambient conditions were performed with very small droplets (diameter of about 50-400 μ m) injected at room temperature at high frequency thanks to a purpose-designed piezoelectric nozzle where the droplet frequency, velocity and size at injection can be adjusted. The target wall was a very thin disk (500 μ m thickness) pre-heated to around 600°C by an electromagnetic inductor device. At initial time, heating was shut down and the heat flux removed from the wall by the impinging droplets (front face of the disk) was calculated by post-processing the temperature field (measured in the rear face of the disk using an infrared camera) with the aid of the semi-analytical inverse heat conduction model that was developed.

To study LOCA conditions closely, a new set-up will be built. The test channel will be representative of a blockage zone. A given droplet distribution will be injected in the channel and both droplet distribution at the exit of the channel and global heat transfer will be measured in order to be compared with the model previously adopted²⁴.

IV. CONCLUSIONS

The most important safety principle in case of a LOCA is to preserve the long-term coolability of the core. The associated safety requirements are to ensure the resistance of the fuel rods upon quench and post-quench loads and to maintain a coolable geometry in the core. In the early 2000's, IRSN has conducted an extensive State-of-the-Art review relative to the fuel behaviour under LOCA conditions. .

The 3 main identified pending or insufficiently investigated technical issues:

- flow blockage within a fuel rods bundle and its potential impact on coolability,
- fuel fragment relocation in the ballooned areas and its potential impact on cladding PCT (Peak Cladding Temperature)
- potential loss of cladding integrity upon quench and post-quench loads.

The PERFROI project (2014-2019) will focus on the first issue above: thermal mechanical aspects of the ballooning phase and thermal hydraulic aspects of the reflooding phase of a partially blocked rod bundle. The knowledge generated by the PERFROI project will benefit the international nuclear safety.

ACKNOWLEDGMENTS

This work is completed within the framework of RSNR Project from a French State aid managed by the National Agency of Research under the program of Investments for the Future carrying the reference n° ANR-11-RSNR-0017.



NOMENCLATURE

COAL : COolability of a fuel Assembly during Loca

COCAGNE : In french « **CO**mportement d'un **C**rayon en **AP**RP soumis à un **Gr**adient de température » - Fuel Rod Behavior under temperature gradient in LOCA conditions

CYCLADES: Characterisation and Investigation for Improved Calculation of LOCA Addressing the Determination and Evaluation of Safety

DRACCAR: Déformation et Renoyage d'un Assemblage de Crayons Combustibles pendant un Accident de Refroidissement – simulation tool for 3D thermal mechanical behavior and Reflooding during LOCA transient.

ELFE : in french « Etablissement des Lois de Fluage » (Creep Law Determination)

FEBA: Flooding Experiments with Blocked Arrays

LOCA: LOSS Of Coolant Accident

SAFRAN: SimULATED Fuel Rod under locA condition

SEFLEX: Simulator Effects in Flooding Experiments

REFERENCES

1. Fukushima, un an après Premières analyses de l'accident et de ses conséquences - Rapport IRSN/DG/2012-001 du 12 mars 2012, Internal IRSN report – (2012).
2. C. Grandjean, A state-of-the-art review of past programs devoted to fuel behaviour under LOCA conditions: Part One, Clad swelling and rupture – Assembly flow blockage, Internal IRSN Technical Report SEMAR 2005/313, December (2005).
3. C. Grandjean, A State-of-the-Art Review of Past Programs Devoted to Fuel Behavior under LOCA Conditions. Part Two, Impact of clad swelling upon assembly cooling, Internal IRSN Technical Report SEMCA-2006/183, June (2006).
4. C. Grandjean, G. Hache, A State-of-the-Art Review of Past Programs Devoted to Fuel Behavior under LOCA Conditions. Part three, cladding oxidation, resistance to quench and post quench loads, Internal IRSN Technical Report SEMCA-2008/093, (2008).
5. Nuclear Fuel Behavior in Loss-of-coolant Accident (LOCA) Conditions: State-of-the-art Report, ISBN 978-92-64-99091-3 © OECD 2009 - NEA No. 6846
6. F. Barré, C. Grandjean, M. Petit, J.C. Micaelli - Fuel R&D Needs and Strategy towards a Revision of Acceptance Criteria, *Science and Technology of Nuclear Science*. (2010)
7. G. Repetto, F. Jacq, F. Barré, F. Lamare, J.M. Ricaud, DRACCAR, a new 3D-thermal mechanical computer code to simulate LOCA transient on Nuclear Power Plants - Status of the development and the validation, ICAPP 2009, Tokyo, Japan, May 10-14, (2009).
8. J.M. Ricaud, N. Seiler, G. Guillard, "Multi-pin Ballooning during LOCA transient: A Three Dimensional Analysis", *Nuclear Engineering and Design (NED)*, 256 45-55, (2013).
9. S. Bascou et al., Computational Analysis of Multi-pin Ballooning during LOCA and Post LOCA Transient using the Multi-physics Code DRACCAR, *Proc. Top Fuel Congress*, Manchester, UK, September 2-6, 2012, American Nuclear Society (2012).
10. S. Bascou, S. Guilbert, G. Guillard, Oxygen diffusion and partially blocked bundle reflooding simulation using DRACCAR, *Proc. Top Fuel Congress 2013*, Charlotte, North Carolina, September 15-19, (2013).
11. M. Gradeck, D. Maillat, F. Lelong, N. Seiler, G. Repetto, Estimation du transfert de chaleur gouttes/paroi en situation d'APRP pour un REP, La Houille Blanche, n°4, pp. 52-57, (2009).
12. C. Grandjean, G. Repetto, F. Barré, Coolability of blocked regions in a rod bundle after ballooning under LOCA conditions, Main findings from a review of the past experimental programmes, NURETH-11 (Nuclear Reactor Thermal Hydraulics) 02-06 October, Avignon France, (2005).
13. C. Grandjean, Coolability of blocked regions in a rod bundle after ballooning under LOCA conditions - Main findings from a review of past experimental programmes, *Nuclear Engineering and Design* 237, pp. 1872-1886, September (2007).
14. E.H. Karb *et al.*, "LWR fuel rod behaviour in the FR2 in-pile tests simulating the heatup phase of a LOCA", KfK 3346, March 1983.
15. P. Ihle, K. Rust, FEBA Flooding Experiments with Blocked Arrays. Evaluation Report KfK 3657, March (1984).
16. P. Ihle, K. Rust, SEFLEX - Fuel Rod Simulator Effects in Flooding Experiments. Part 1: Evaluation Report, KfK 4024, March (1986).
17. L. Kekkonen, "LOCA testing at Halden, the fourth experiment IFA-650.4", OECD Halden Reactor Project, HWR-838, (2007).
18. S. Frechinet, « Transformations et comportement du zircaloy-4 en conditions anisothermes » Thèse de doctorat (PhD research), Ecole des Mines de Paris, 2001.
19. V. Busser, M-C Baietto-Dubourg, J. Desquines, J-P Mardon, Mechanical response of oxidized Zircaloy-4 cladding material submitted to a ring compression test, *Journal of Nuclear Materials* 384 (2009) 87-95
20. N. Tardif, M. Coret, A. Combescure, Experimental study of the fracture kinetics of a tubular 16MnNiMo5 steel specimen under biaxial loading at 900 and 1,000% Application to the rupture of a vessel bottom head during a core meltdown accident in a pressurized water reactor, *Nuclear Engineering and Design*, Vol. 241 (3), pp. 755-766 (2011).
21. K. G. Pearson, C.A. Cooper, D. Jowitt, J.H. Kinneir, Reflooding Experiments on a 49-Rod Cluster Containing a Long 90% Blockage, AEEW – R 1591, January (1983).
22. C.A. Cooper, K.G. Pearson, D. Jowitt - The THETIS 80% Blocked Cluster Experiment. Forced Reflood Experiments - Part 3: AEEW – R 1765, September 1984 and Gravity Reflood Experiments - Part4: AEEW – R 1766, September (1984).
23. F. Lelong, M. Gradeck, N. Seiler, P. Ruyer, G. Castanet and P. Dunand, Dynamic behaviour of droplet bouncing onto hot slab, ILASS – Europe 2010, 23rd Annual Conference on Liquid Atomization and Spray Systems, Brno, Czech Republic, September (2010).
24. P. Ruyer, N. Seiler, B. Biton, F. Lelong, F. Secondi, D. Baalbaki, M. Gradeck, Thermal hydraulic across a partially damaged core during the reflood phase of a LOCA, *Nuclear Engineering and Design (NED)* (2013), <http://dx.doi.org/10.1016/j.nucengdes.2013.02.026>