

AN ANALYSIS OF CRITICALITY SAFETY « NEAR MISSES »

Fabien DURET, Matthieu DULUC,
Johann HERTH (speaker)

PRESENTATION OUTLINE

- Classification of near misses according to different types of original deficiencies, consequence levels and involvement of Human and Organizational Factors (HOF)
- 7 examples of “near misses” (with elements justifying their classifications)
- Analysis of the distribution of “near misses” according to the different categories, and conclusions

CLASSIFICATION OF NEAR MISSES

[ACCORDING TO DIFFERENT TYPES OF ORIGINAL DEFICIENCIES, CONSEQUENCE LEVELS AND INVOLVEMENT OF HOF (1/2)

■ In 1989, the French Criticality Safety Commission (CSC) classified 12 French events as “near misses” and sorted them according to different types of original deficiencies:

- A. « A detail that was missed »
- B. Underestimation or lack of knowledge of a physical phenomenon
- C. Discrepancy between safety analysis and reality
- D. Lack of basic training in criticality safety
- E. Lack of knowledge or forgetting the purpose of a safety measure

■ In 2020-2022, IRSN Criticality Safety Department has updated this analysis, considering:

- **25 near misses**, including 13 other events that occurred (in France, USA, GB and Japan) between 1983 and 2017.
- These events were all assessed by IRSN using “LOGIC”, a “Learning From Experience” (LFE) database dedicated to criticality safety events.
 - see specific paper and poster about LOGIC and the criticality safety analysis guide.

CLASSIFICATION OF NEAR MISSES

[ACCORDING TO DIFFERENT TYPES OF ORIGINAL DEFICIENCIES, CONSEQUENCE LEVELS AND INVOLVEMENT OF HOF (2/2)

■ A classification of these near misses according not only to original deficiencies, but also to different consequence types and to the level of involvement of Human and Organizational Factors (HOF):

- 4 consequence types (corresponding to different definitions of the notion of “near misses”):

Critical conditions:

1. were nearly reached
2. remained away only thanks to a fast human action
3. were potentially reached under other authorized conditions
4. remained away even potentially, and the event is considered as a near miss for other reasons (prolonged or definitive shutdown, very worrying breach of operating rules, etc.)

- 4 levels of involvement of HOF:

→ see details later

FRANCE, '70s

[UNINTENDED TRANSFER OF A FISSILE SOLUTION TO AN ALREADY FULL ANNULAR TANK

Sequence of events

- **Paraffin and Cadmium:** the tank's central cavity was filled with **paraffin** and coated with **cadmium** foil (neutron poison).

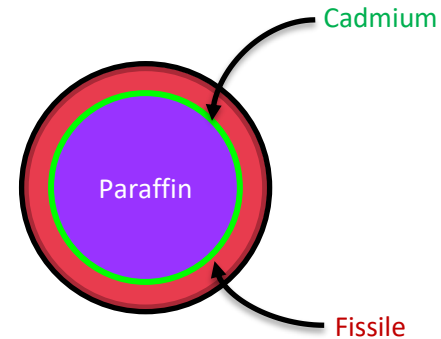
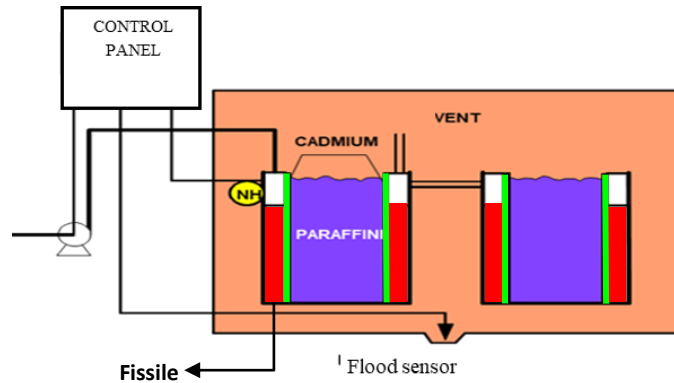
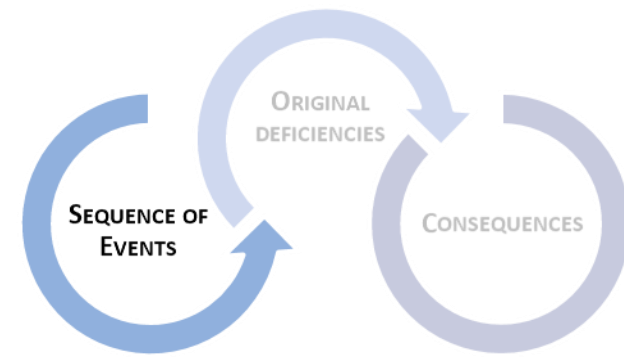

FRANCE, '70s

[UNINTENDED TRANSFER OF A FISSILE SOLUTION TO AN ALREADY FULL ANNULAR TANK

■ Sequence of events

- **Paraffin and Cadmium:** the tank's central cavity was filled with paraffin and coated with cadmium foil (neutron poison).
- **Acid Overflowed:** initiating corrosion of a small exposed cadmium part.
 - Heating melted the paraffin and release gas.
 - Paraffin transformed into foam, ejected from the tank, inhibiting a flood detector
 - The fissile solution filled the volume originally occupied by the paraffin.

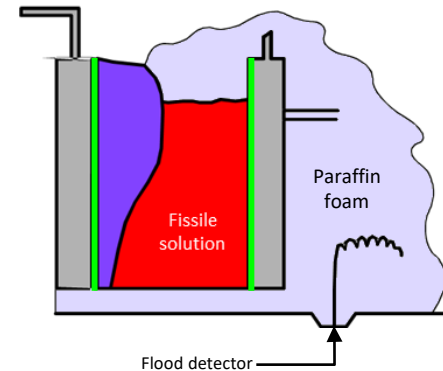
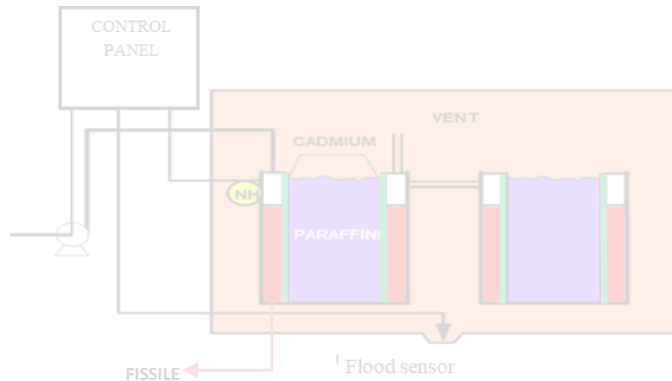
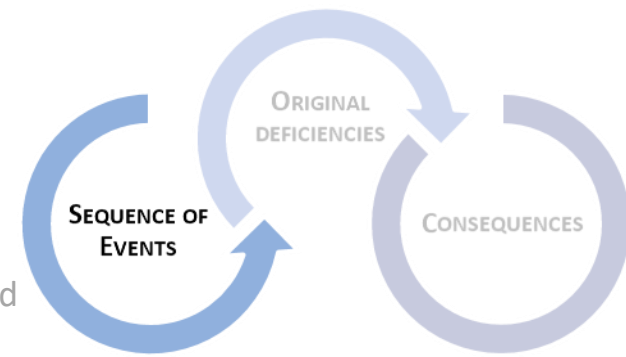

FRANCE, '70s

[UNINTENDED TRANSFER OF A FISSILE SOLUTION TO AN ALREADY FULL ANNULAR TANK

Original deficiency: type A, due to "several missed details"

- **Faulty Warning Light:** did not signal the unintended transfer control.
- **Clogged Overflow:** machining chips in the tank clogged an overflow orifice.
- **Vertical vent:** caused internal overflow, toward the center of the tank.
- **Cadmium Exposure:** a bit of cadmium was sticking out of the paraffin.

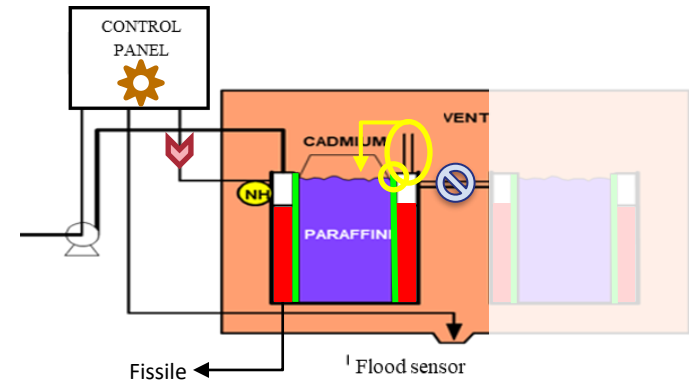
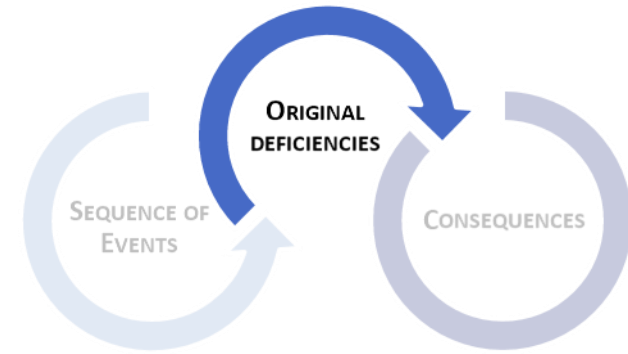

FRANCE, '70s

[UNINTENDED TRANSFER OF A FISSILE SOLUTION TO AN ALREADY FULL ANNULAR TANK

Original deficiency: type A, due to “several missed details”

- **Faulty Warning Light:** did not signal the unintended transfer control.
- **Clogged Overflow:** machining chips in the tank clogged an overflow orifice.
- **Vertical vent:** caused internal overflow, toward the center of the tank.
- **Cadmium Exposure:** a bit of cadmium sticking out of the paraffin.

Consequences: type 3 (“Critical conditions potentially reached”)

- Subcriticality was maintained thanks to the operational fissile concentration (10 g/L)
- But an accident could have occurred with the maximum authorized concentration (50 g/L), despite cadmium's absorbing effect.

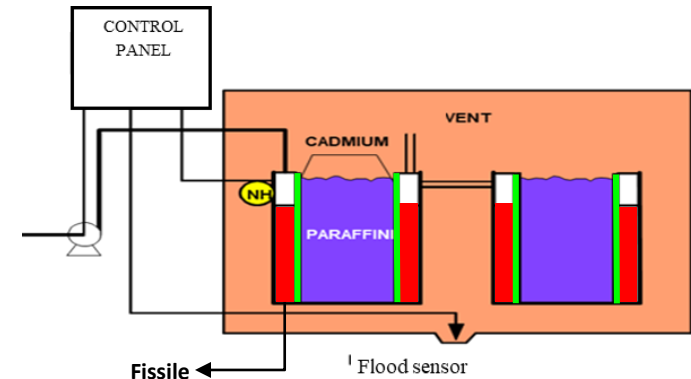
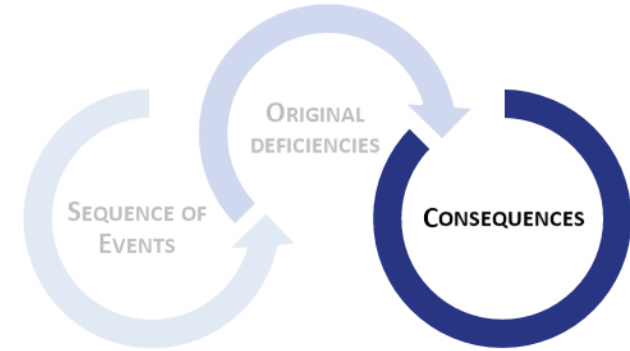

FRANCE, '70s

[PLUTONIUM SLOW ACCUMULATION IN A URANIUM-GRAPHITE-GAS FUEL DISSOLVER

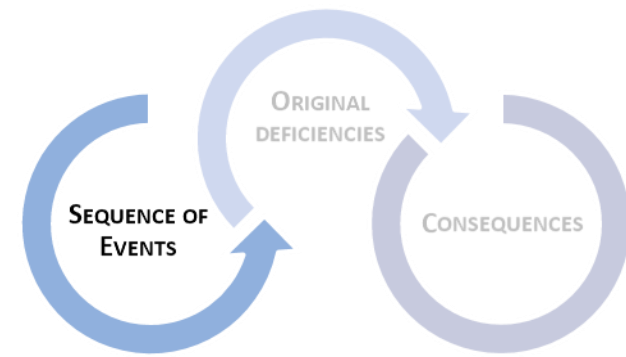

Sequence of events

- **Context:** abnormal accumulation of Pu in a dissolver for natural uranium-graphite-gas reactor assemblies.
- **Detection:** unusually high temperature.
- **Implication:** accumulation of fission products.

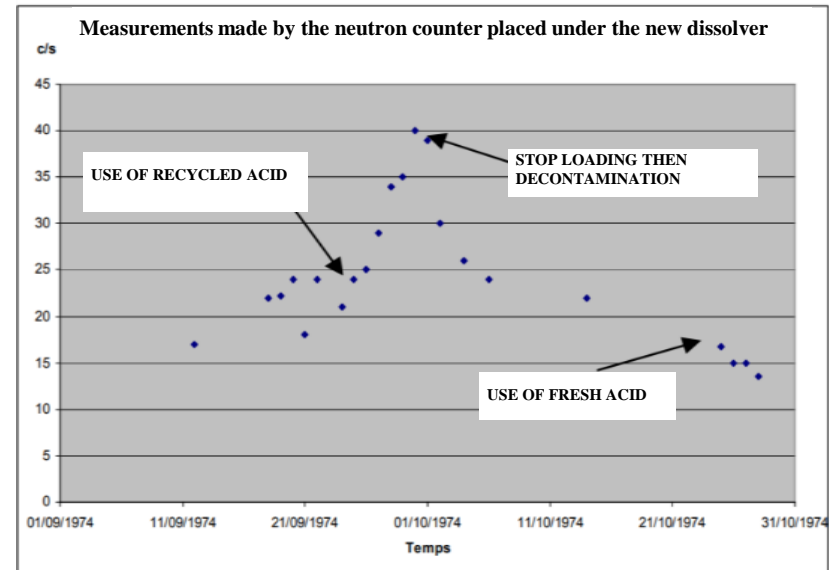

FRANCE, '70s

[PLUTONIUM SLOW ACCUMULATION IN A URANIUM-GRAPHITE-GAS FUEL DISSOLVER

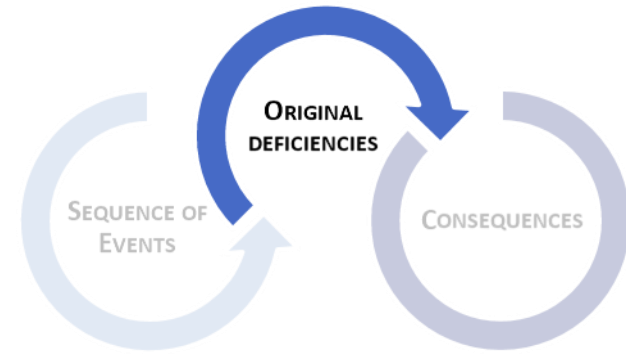

| Sequence of events

- **Context:** abnormal accumulation of Pu in a dissolver for natural uranium-graphite-gas reactor assemblies.
- **Detection:** unusually high temperature.
- **Implication:** accumulation of fission products.

| Original deficiency: Type B (“*unknown physical phenomenon*”)

- **Phenomenon:** Pu had been adsorbed on precipitates of zirconium phosphates (fission product).
- **Cause:** Use of recycled acid and water containing tributyl phosphate (TBP) or its degradation products in the dissolver.

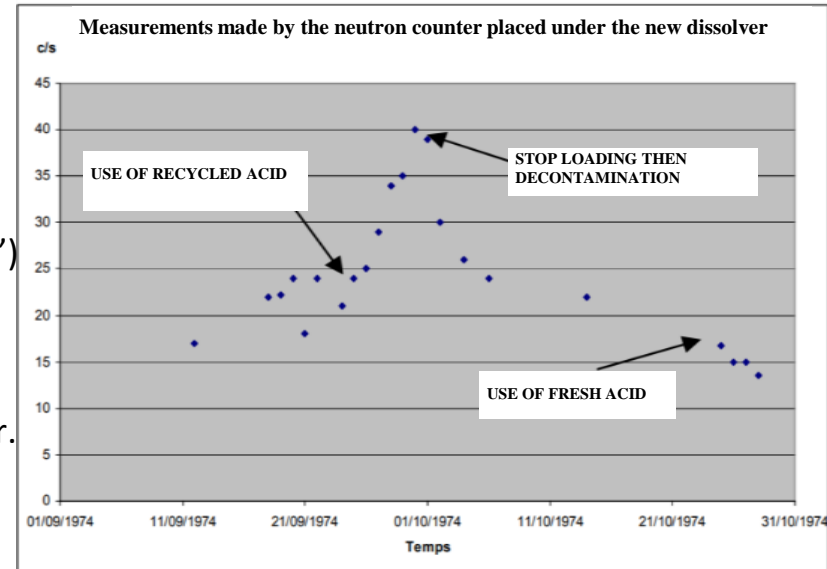

FRANCE, '70s

[PLUTONIUM SLOW ACCUMULATION IN A URANIUM-GRAPHITE-GAS FUEL DISSOLVER

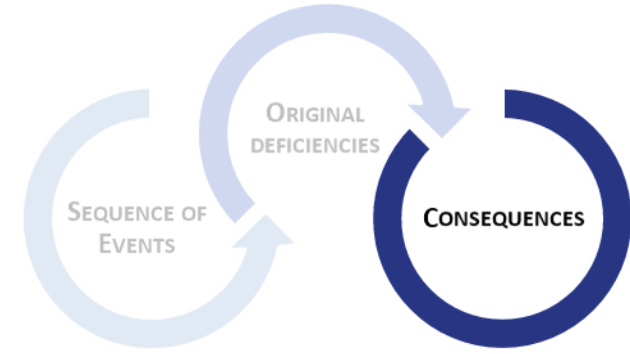

Consequences: type 1 (“critical conditions nearly reached”).

Precipitates had resisted to acid rinses at the end of dissolution campaigns.

→ accumulation of 4.5 times the minimum critical mass of plutonium oxyfluoride (PuO_2F_2 with 13% ^{240}Pu moderated and reflected by water, in an unsafe geometry).

Actions taken: after the event, multiple studies and tests have been set up to identify this phenomenon:

- Recover the precipitates (first basic rinses to “break” them, then boiling acid rinses...).
- Continue to use the large stock of recycled acid, but after forced precipitation with zirconium and filtration to “purify” it.
- Use a new dissolver equipped with a neutron counter to monitor the formation of precipitates.

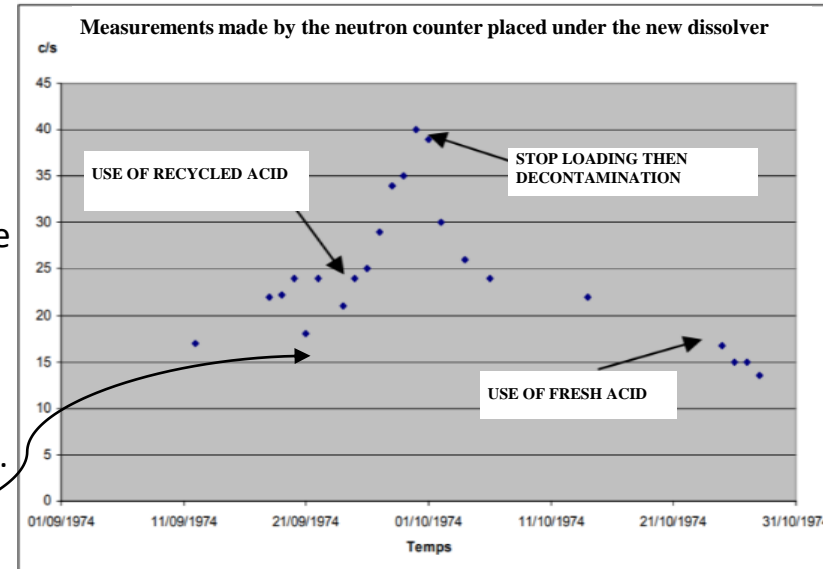

BWXT (USA), 2007

[FALL OF A VACUUM CLEANER FILLED WITH RASCHIG RINGS (*BOROSILICATE GLASS*) AND URANIUM SOLUTION

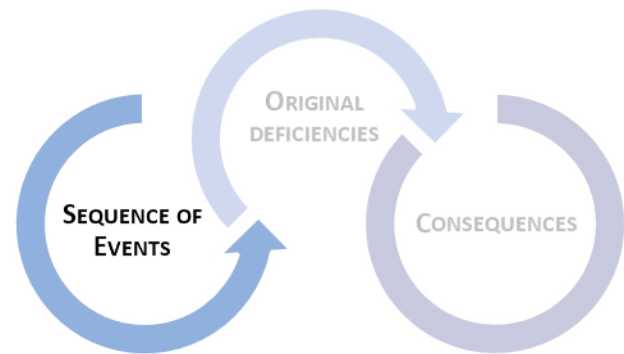
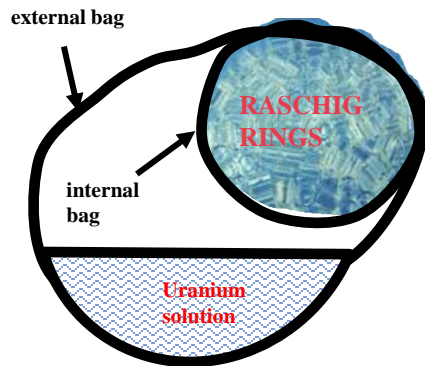

Sequence of events

- The vacuum cleaner was packed in two plastic bags and placed on a forklift without proper lifting attachments.
- During a transfer, the vacuum cleaner fell off the forklift when it climbed an access ramp:
 - The fissile solution leaked into the outer bag in an unsafe geometry.
 - The Raschig rings partially spilled out of the vacuum cleaner but remained within the inner bag.

BWXT (USA), 2007

[FALL OF A VACUUM CLEANER FILLED WITH RASCHIG RINGS (BOROSILICATE GLASS) AND URANIUM SOLUTION

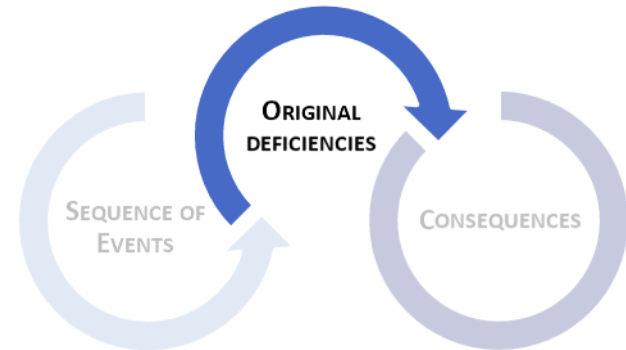
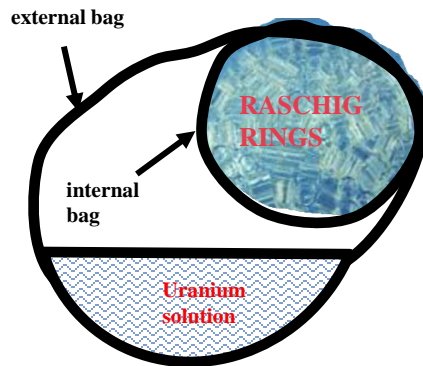

Original deficiency: type C (“discrepancy between the safety analysis and reality”)

- Handling conditions were not documented in the safety report and were not known by the criticality safety specialists.

BWXT (USA), 2007

[FALL OF A VACUUM CLEANER FILLED WITH RASCHIG RINGS (*BOROSILICATE GLASS*) AND URANIUM SOLUTION

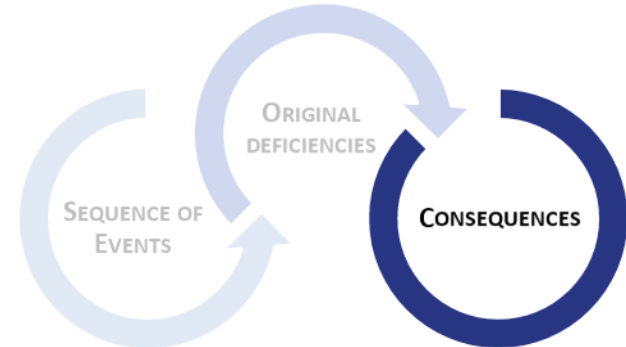
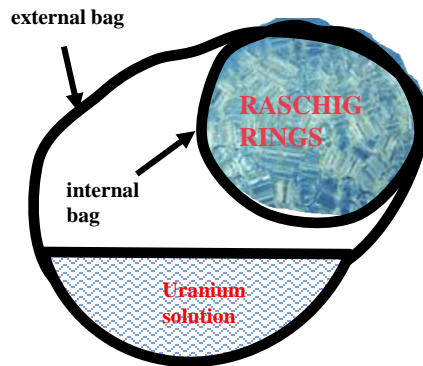

Original deficiency: type C (“discrepancy between the safety analysis and reality”)

- Handling conditions were not documented in the safety report and were not known by the criticality safety specialists

Consequences: type 3 (“potential criticality”)

- Subcriticality acquired because of low ^{235}U concentration, but which could have been challenged under other authorized conditions (up to 32 L of solution at 400 g/L ^{235}U)

LOS ALAMOS (USA), 2011

[GATHERING OF FISSILE METALLIC OBJECTS NORMALLY SEPARATED BY MINIMAL DISTANCES

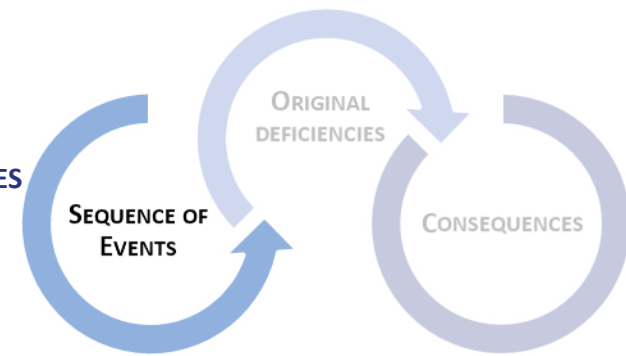

Sequence of events:

- To take a photograph, technicians gathered 8 metallic Pu rods (normally separated by minimal distances).
- In addition, a supervisor asked the workers to separate the parts immediately, instead of taking the usual precaution.



LOS ALAMOS (USA), 2011

[GATHERING OF FISSILE METALLIC OBJECTS NORMALLY SEPARATED BY MINIMAL DISTANCES

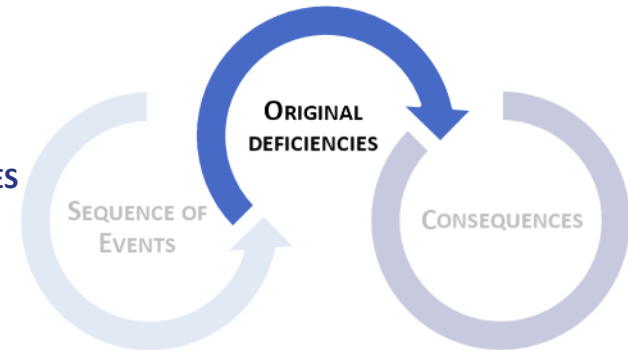

Sequence of events:

- To take a photograph, technicians gathered 8 metallic Pu rods (normally separated by minimal distances).
- In addition, a supervisor asked the worker to separate the parts immediately, instead of taking the usual precaution.

Original deficiency: type D (“*lack of criticality safety training*”)

- “**Desensitization**”: staff was unaware of the criticality risk.
- **Context**: precursory anomalies and tensions between criticality safety teams and management led to shortcomings in oversight and operational guidance.



LOS ALAMOS (USA), 2011

[GATHERING OF FISSILE METALLIC OBJECTS NORMALLY SEPARATED BY MINIMAL DISTANCES

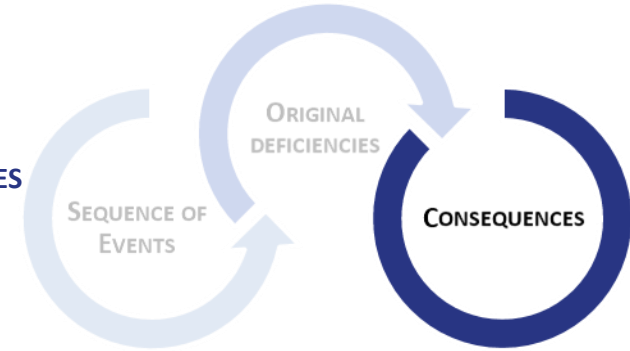

Consequences:

- **Type 2** (“critical conditions remained away only thanks to a fast-human action”) Without being stopped by the supervisor, operators might have grouped even more items, approaching critical conditions.
- **Type 4** (“strong impact on the operating conditions”)
 - This event (and the context) caused an "exodus" of criticality safety engineers.
 - Plutonium processing operations halted for several years.



DAMPIERRE PWR (FRANCE), 2001

[SHIFT IN THE POSITION OF 113 CONSECUTIVE ASSEMBLIES IN THE CORE OF THE REACTOR BUILDING

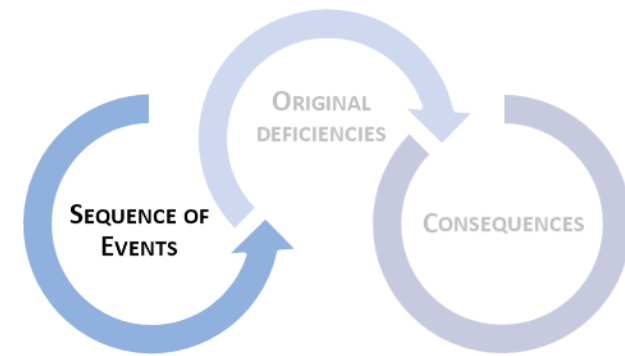
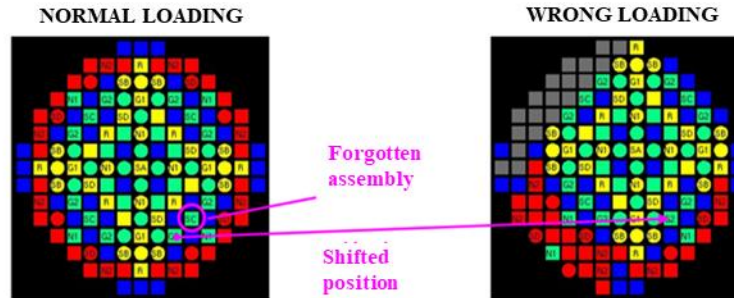

Sequence of events:

- Following a change of roles of workers in the fuel storage building, one assembly was mistakenly left in the pool, because its transfer sheet had been filled before the real transfer (to save time).
- This led to the shift of the next 113 assemblies in the reactor core.

DAMPIERRE PWR (FRANCE), 2001

[SHIFT IN THE POSITION OF 113 CONSECUTIVE ASSEMBLIES IN THE CORE OF THE REACTOR BUILDING

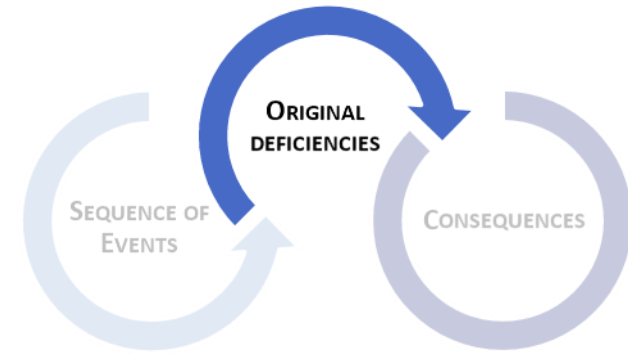
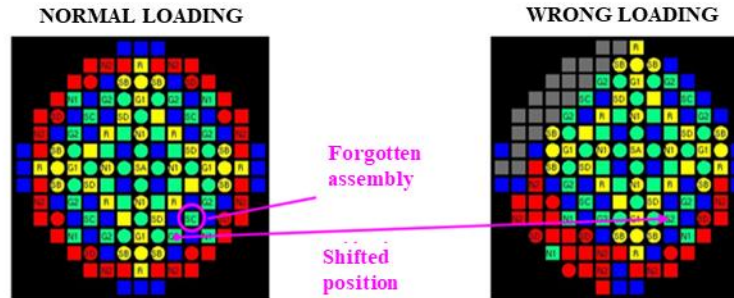

Original deficiency: type E (“forgetting the purpose of safety measures”)

- The assembly's identification, crucial for the correct sequence, was only done in the spent fuel pool. The reactor team operated based on the sequence of assemblies, not their identification numbers.
- Some required controls had been skipped (matching of absorbing rods and assemblies in the reactor, transfer sheets in the spent fuel pool) → delayed detection

DAMPIERRE PWR (FRANCE), 2001

[SHIFT IN THE POSITION OF 113 CONSECUTIVE ASSEMBLIES IN THE CORE OF THE REACTOR BUILDING

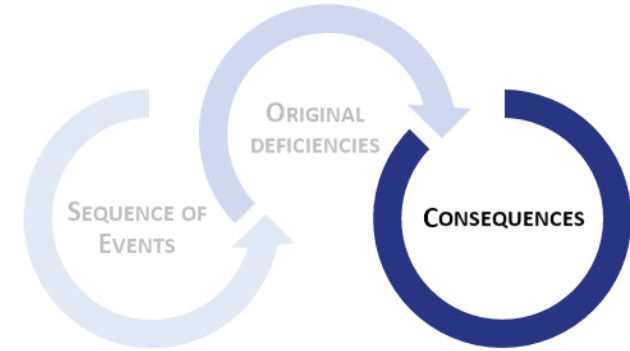
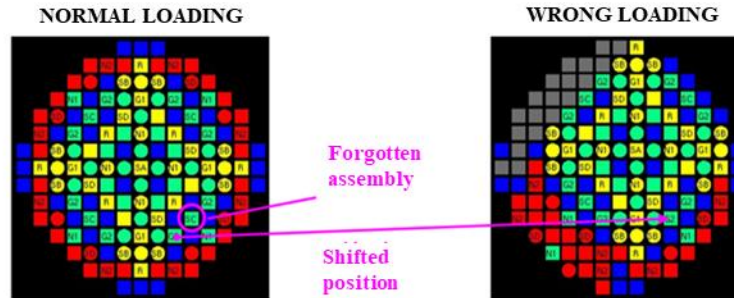

Original deficiency: type E (“forgetting the purpose of safety measures”)

- The assembly's identification, crucial for the correct sequence, was only done in the spent fuel pool. The reactor team operated based on the sequence of assemblies, not their identification numbers.
- Some required controls had been skipped (matching of absorbing rods and assemblies in the reactor, transfer sheets in the in the spent fuel pool) → delayed detection

Consequences: type 3 (“potential criticality”)

- Under more penalizing conditions (minimum boron content, less irradiation), criticality could have been reached around 121 shifted assemblies ($\cong 113$).

FRANCE, 70s

[SHEARED PIECES OF FUEL ASSEMBLIES DISSOLVED IN A TUBE OF UNSAFE GEOMETRY

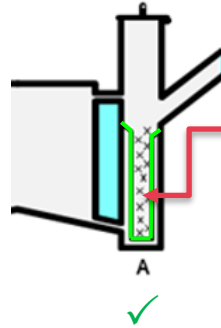

In normal conditions, sheared pieces of fuel assemblies were put in a basket of safe geometry and then dissolved

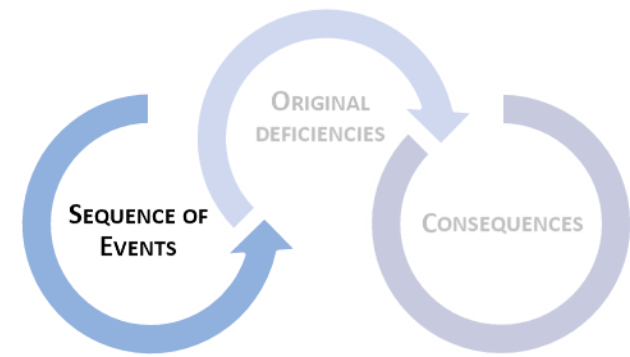

FRANCE, 70s

[SHEARED PIECES OF FUEL ASSEMBLIES DISSOLVED IN A TUBE OF UNSAFE GEOMETRY

The unlocking of the shear is linked to the closing of the **tube caps**

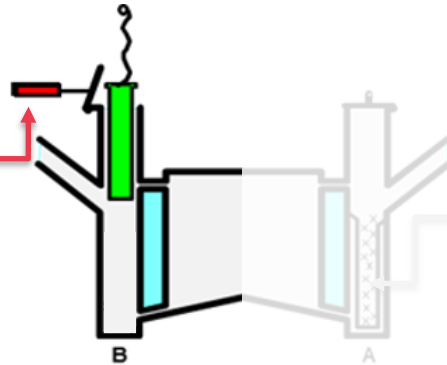

In normal conditions, sheared pieces of fuel assemblies were put in a basket of safe geometry and then dissolved

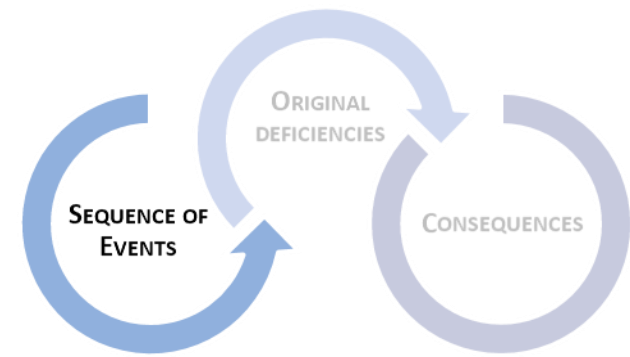

FRANCE, 70s

[SHEARED PIECES OF FUEL ASSEMBLIES DISSOLVED IN A TUBE OF UNSAFE GEOMETRY

- The unlocking of the shear is linked to the closing of the tube caps
- The basket had remained hooked to the **handling clamp** → The pieces of an assembly were dissolved directly in the tube of unsafe geometry

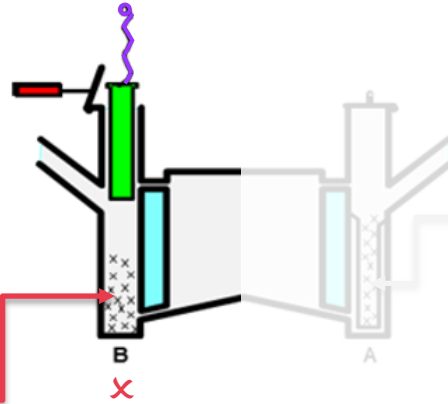

In normal conditions, sheared pieces of fuel assemblies were put in a basket of safe geometry and then dissolved

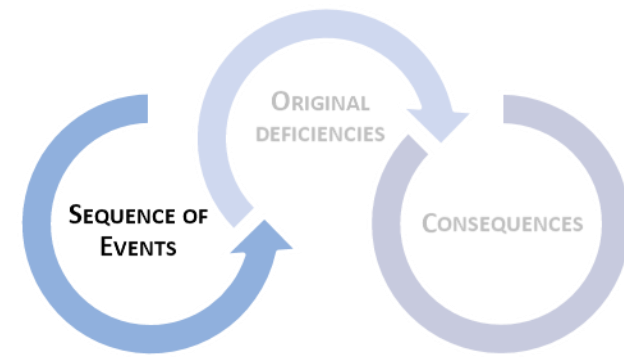

FRANCE, 70s

[SHEARED PIECES OF FUEL ASSEMBLIES DISSOLVED IN A TUBE OF UNSAFE GEOMETRY

■ type E (“forgetting the purpose of safety measures”)

- **Original design:** one clamp for basket handling and tube cap closing.
→ the event would not have occurred (can't close tube cap while clamp handles basket)
- Also a mechanical issue: basket release signal based on air pressure, not clamp's actual state. Air pressure sufficient to activate signal, but not to release basket, due to sealing defect.

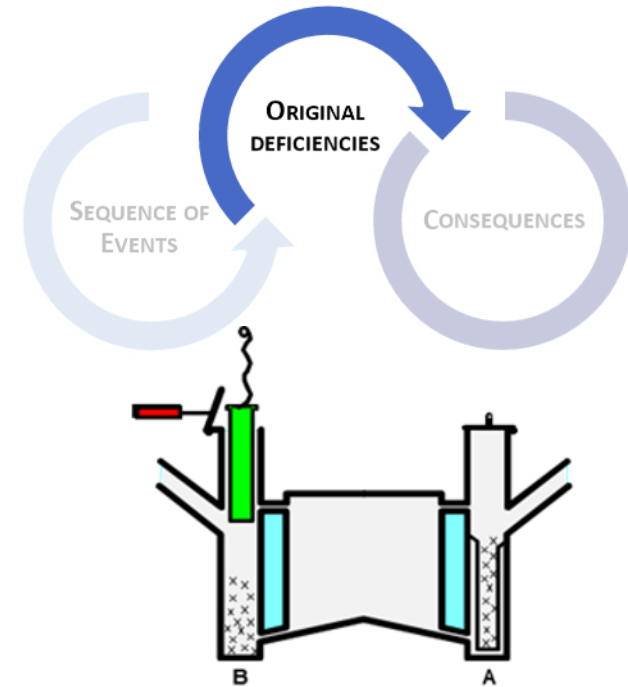

FRANCE, 70s

[SHEARED PIECES OF FUEL ASSEMBLIES DISSOLVED IN A TUBE OF UNSAFE GEOMETRY

■ type E (“forgetting the purpose of safety measures”)

- **Original design:** one clamp for basket handling and tube cap closing.
→ the event would not have occurred (can't close tube cap while clamp handles basket)
- Also a mechanical issue: basket release signal based on air pressure, not clamp's actual state. Air pressure sufficient to activate signal, but not release basket, due to sealing defect.

■ Type 4 (“strong impact on operating conditions”)

- Subcriticality would have been achieved thanks to the burn-up and dissolution speed, even potentially with the maximum authorized uranium enrichment.
- But it took 4 years to improve the clamp opening/closing signal system.

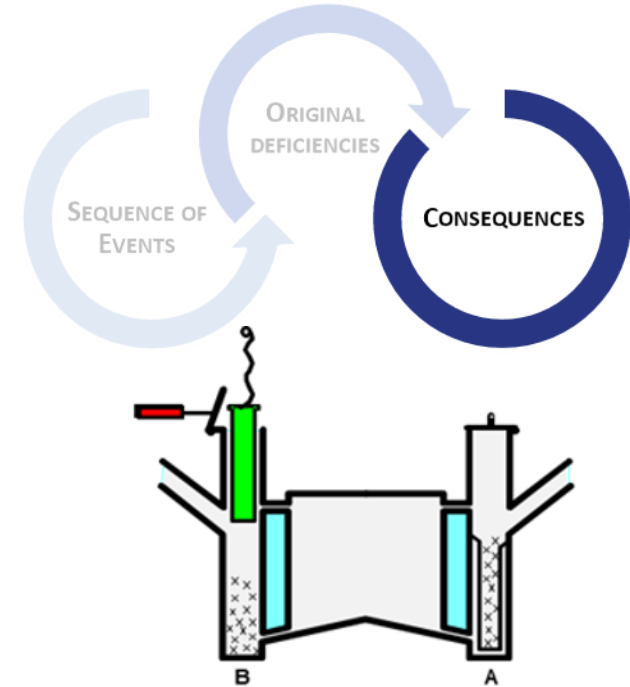

Y12 NSC (USA), 2017

[WATER LEAK NEAR A SLAG CHUTE OF UNSAFE GEOMETRY CONTAINING AN UNSUSPECTED MASS OF URANIUM (UNCONTROLLED ACCUMULATION)

■ **Calciothermy:** $\text{UF}_4 + 2 \text{Ca}$ (mixed powders) \rightarrow U (metal) + 2CaF_2 (slag)

- Progressive degradation of the calciothermal process:
- \rightarrow abnormal high quantities of uranium in the fluorite slag, making it difficult to grind it.
 - \rightarrow slag fragments overflowed from a receiver box and entered the chute.

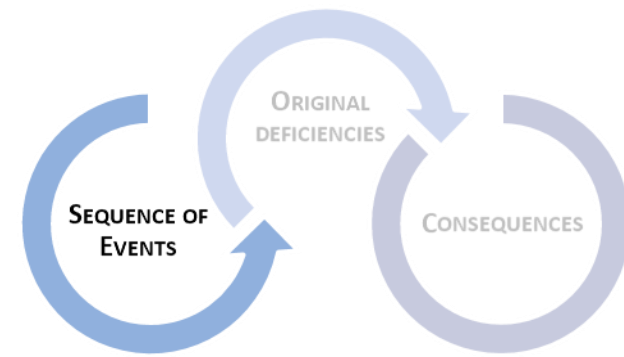

Fig. 1 Sand separator (left) and slag chute with can (right)

Y12 NSC (USA), 2017

[WATER LEAK NEAR A SLAG CHUTE OF UNSAFE GEOMETRY CONTAINING AN UNSUSPECTED MASS OF URANIUM (UNCONTROLLED ACCUMULATION)

■ **Calciothermy:** $\text{UF}_4 + 2 \text{Ca}$ (mixed powders) \rightarrow U (metal) + 2 CaF_2 (slag)

■ Progressive degradation of the calciothermal process
 \rightarrow abnormal high quantities of uranium in the fluorite slag, making it difficult to grind it
 \rightarrow slag fragments overflowed from a receiver box and entered the chute

■ **type E** (“*forgetting the purpose of safety measures*”)
▪ periodic emptying of the receiver box was foreseen in the design, but finally abandoned, since the quantity of fragments was negligible when calciothermy was functioning correctly.

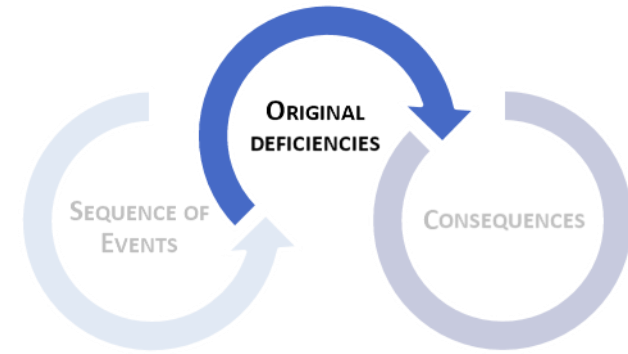

Fig. 1 Sand separator (left) and slag chute with can (right)

Y12 NSC (USA), 2017

[WATER LEAK NEAR A SLAG CHUTE OF UNSAFE GEOMETRY CONTAINING AN UNSUSPECTED MASS OF URANIUM (UNCONTROLLED ACCUMULATION)

■ **Calciothermy:** $UF_4 + 2 Ca$ (mixed powders) $\rightarrow U$ (metal) + $2 CaF_2$ (slag)

■ Progressive degradation of the calciothermal process
 \rightarrow abnormal high quantities of uranium in the fluorite slag, making it difficult to grind it
 \rightarrow slag fragments overflowed from a receiver box and entered the chute

- **Type E** (“*forgetting the purpose of safety measures*”)
- periodic emptying of the receiver box was foreseen in the design, but finally abandoned, since the quantity of fragments was negligible when calciothermy was functioning correctly.
- **Type 2** (“*critical conditions remained away only thanks to a fast human action*”)
- a worker cut off the water supply just in time (water was only mixed with a thin layer of sand)

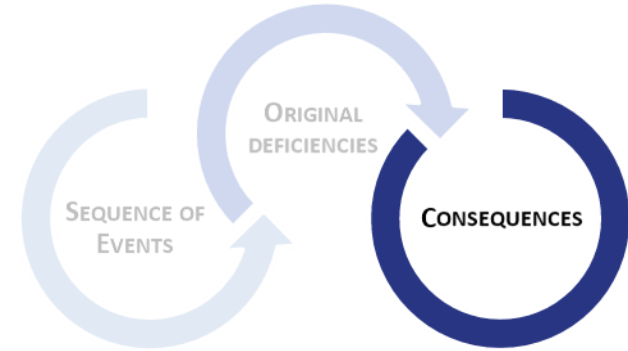
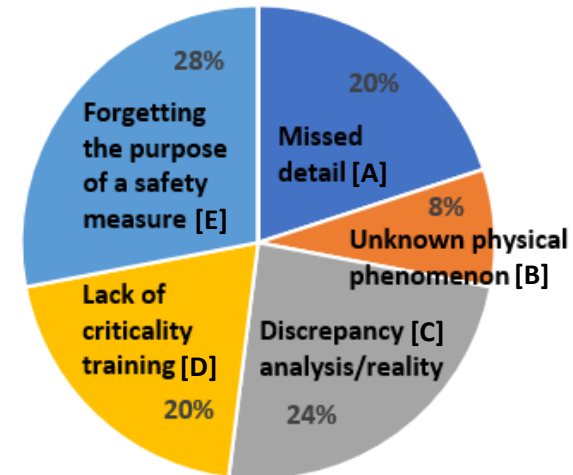
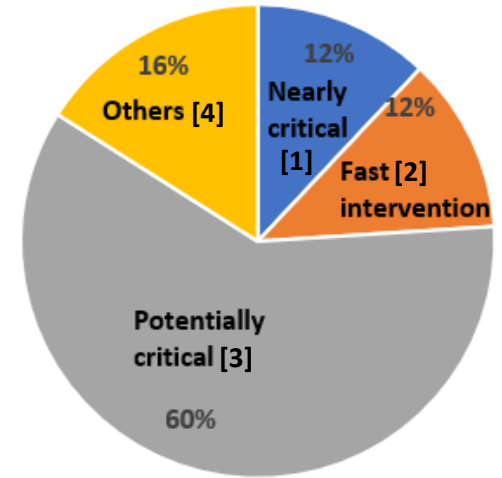

Fig. 1 Sand separator (left) and slag chute with can (right)

DISTRIBUTION OF THE NEAR MISSES

[ACCORDING TO ORIGINAL DEFICIENCY TYPES AND CONSEQUENCE TYPES

- Type 3 consequences gather most of the near misses.
- Near misses are distributed almost uniformly among original deficiency types, except for **type B**, which is:
 - Almost as frequent as others if we look only at the 12 events considered by the CSC in 1989.
 - Less frequent than others if we consider all the 25 near misses up to 2017.
 - Physical phenomena initially unknown became more and more known & controlled.
- But we are currently facing a renewal of nuclear facilities so we could face **new underestimated or unknown phenomena**.
- **HOF are little involved in this type of deficiency**.
- **Only remedies** : completeness and validation of prior theoretical studies, robust engineering designs and monitoring systems.



DISTRIBUTION OF THE NEAR MISSES

[ACCORDING TO HOF INVOLVEMENT LEVEL

Concerning HOF, in a first approach, they are obviously:

- little involved in type B original deficiencies.
- highly involved in type D or E deficiencies, which are linked to organizational failures, concerning either the operation or the origins of the design.
→ *This point is illustrated by the loading of a dissolver without basket (France, 70s), as the use of jacks to close the dissolver plugs may have not been discussed with safety engineers who had initially planned to use the clamp.*
- partially involved in type A original deficiencies, some being errors that could have been detected earlier by better monitoring of interventions, and in type C deficiencies, with a lack of information from staff to safety engineers.
- involved favorably in near misses with type 2 consequences, as the reaching of critical conditions was avoided thanks to a fast human intervention.
→ *for example, the water leak near a cavity containing accumulated uranium, as the water supply was cut off just in time.*

- A. Missed detail
- B. Unknown physical phenomenon
- C. Discrepancy analysis/reality
- D. Lack of criticality training
- E. forgetting the purpose of a safety measure

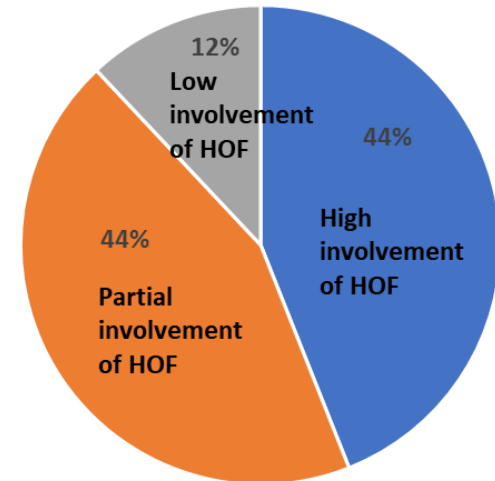



THANK YOU ! QUESTIONS ?

For more details, feel free to contact Fabien DURET
(fabien.duret@irsn.fr)

THE 12TH
INTERNATIONAL CONFERENCE ON **NUCLEAR CRITICALITY SAFETY**

ORGANIZED BY



CO-ORGANIZED BY





BACKUP SLIDES

ICNC
2023
SENDAI

THE 12TH
INTERNATIONAL CONFERENCE ON **NUCLEAR CRITICALITY SAFETY**

ORGANIZED BY



CO-ORGANIZED BY



Q&A

1. Q: FR 70s', US 20s' → Pas/peu d'incidents FR après les années 2000 ? FR > US ? Pas d'incident IK, JP ?
R: **We have chosen events to illustrate each category (not representative of all the events in the database).**
2. Q: Quelle est notre légitimité à présenter des incidents US?
R: **These events are well documented in international literature.**
3. Q: Comment classe-t-on un incident en presque-accident?
R: **An event that was close to critical conditions**
4. Q: Pourquoi classement dans telle catégorie (surtout en termes de conséquences) plutôt qu'une autre ?
R: **There's an element of subjectivity in the classification. Some consequences can fall into 2 categories, and the line can be very fine (I agree) But the main deep cause has been retained.**
5. Q: Pourquoi ne pas dire où se sont produits tous les incidents français.
R: **I'm not allowed to tell you so (for now), since some of the french near-misses have not been published internationally. All the data are not open for now, but there's an ongoing task for that.**
6. Q: Citer un exemple de presque-accident UK ou JP ?
R: **UK: Magnox (Sellafield) / JP: Rod withdrawal @Shika Nuclear power station.**
7. **I can write down the question and get back to you during the conference.**