



HAL
open science

Uptake of technetium-99 by food crops under field conditions

Sviatoslav Levchuk, Brenda Howard, Valery Kashparov, Vasyl Yoschenko,
Pierre Hurtevent

► **To cite this version:**

Sviatoslav Levchuk, Brenda Howard, Valery Kashparov, Vasyl Yoschenko, Pierre Hurtevent. Uptake of technetium-99 by food crops under field conditions. *Journal of Environmental Radioactivity*, 2024, 276, pp.107442. 10.1016/j.jenvrad.2024.107442 . irsn-04662125

HAL Id: irsn-04662125

<https://irsn.hal.science/irsn-04662125v1>

Submitted on 4 Sep 2024

HAL is a multi-disciplinary open access archive for the deposit and dissemination of scientific research documents, whether they are published or not. The documents may come from teaching and research institutions in France or abroad, or from public or private research centers.

L'archive ouverte pluridisciplinaire **HAL**, est destinée au dépôt et à la diffusion de documents scientifiques de niveau recherche, publiés ou non, émanant des établissements d'enseignement et de recherche français ou étrangers, des laboratoires publics ou privés.



Distributed under a Creative Commons Attribution - NonCommercial - NoDerivatives 4.0
International License

Uptake of technetium-99 by food crops under field conditions

Sviatoslav Levchuk^a , Brenda Howard^b, Valery Kashparov^a, Vasyl Yoschenko^{a,1},
Pierre Hurtevent^c

^a *Ukrainian Institute of Agricultural Radiology (UIAR) of National University of Life and Environmental Sciences of Ukraine (NUBiP of Ukraine), Mashynobudivnykiv Str.7, Chabany, Kyiv Region, 08162 Ukraine*

^b *UK Centre for Ecology & Hydrology – Lancaster (CEH), Lancaster Environment Centre, Library Avenue, Bailrigg, Lancaster, LA1 4AP, UK*

^c *French Institute of Radiological Protection and Nuclear Safety (IRSN), PRP-ENV/SERIS/L2BT, CE Cadarache bt 186, BP 3,13115 Saint-Paul-lez-Durance, France*

Abstract. Long-term field experiments have been carried out in the Chernobyl Exclusion zone to determine parameters describing technetium (⁹⁹Tc) transfer into five food plants (Lettuce, Radish, Wheat, Bean, and Potato) from four types of soil, namely Podzoluvisol, Greyzem, Phaeozem, and Chernozem. Technetium was added to the soils under field conditions in a pertechnetate form. In the first two years, soil type had little effect on Tc uptake by plants. In the first and second years after contamination, the concentration ratios (CR), defined as ⁹⁹Tc activity concentration in the crop (dry weight) divided by that in the soil (dry weight), for radish roots and lettuce leaves ranged from 60 to 210. For potato tubers, the CR was 0.4-2.3, i.e., two orders of magnitude lower than for radish and lettuce, and for summer wheat grain it was lower at 0.6±0.1. After 8-9 years, root uptake of ⁹⁹Tc by wheat decreased by 3-7 fold (CR from 0.016±0.005 to 0.12±0.034) and only 13-22 % of the total ⁹⁹Tc added remained in the upper 20 cm soil layers. The time taken for half of the added ⁹⁹Tc to be removed from the 20-cm arable soil layer due to vertical migration and transfer to plants was short at c. 2-3 years.

Keywords: ⁹⁹Tc, technetium, soil, plant, concentration ratio, root uptake, radioecology

Introduction

 Corresponding author. E-mail address: <mailto:levchuk.s@nubip.edu.ua>

¹ Present address: Institute of Environmental Radioactivity at Fukushima University, 1 Kanayagawa, Fukushima, 960-1296 Japan

29 Tc-99 is a β -emitter (β -, 100%) with an average spectrum energy $E_{av}=85.4$ keV and a long
30 physical half-life ($T_{1/2} = 2.11 \cdot 10^5$ y). It is mainly produced during the fission of ^{235}U and ^{239}Pu
31 with yields of about 6%. A rough estimation by Garcia-Leon (2005) stated that about 2000 TBq
32 of ^{99}Tc was released into the environment from all possible sources up to the year 2000, and that
33 about 64 GBq of ^{99}Tc had been produced worldwide during the last century.

34 Technetium is considered to be highly mobile in oxidized environments (Wildung et al.,
35 1986). Due to its long half-life and high environmental mobility ^{99}Tc is a potential contributor to
36 future radiation doses to humans and other living organisms, and is a particularly important
37 radionuclide with respect to radioactive waste management. Therefore, there is considerable
38 current interest in ^{99}Tc behaviour in the environment, including the study of its mobility in soil
39 and its bioavailability for uptake by plants and animals. Such information is essential for
40 informed assessment of the environmental impacts of terrestrial nuclear storage facilities.

41 Technetium exists in all oxidation states from +7 to -1; the +4 and 0 states are the most stable
42 (Curtis et al., 1999; Rosotti, 1998). The anion TcO_4^- (pertechnetate, oxidation state +7), which is
43 produced during nuclear fuel processing, is the most likely form to be released into the
44 environment (Till, 1986). The stability diagram for technetium shows that TcO_4^- will be stable in
45 aerobic soils and will be reduced in anaerobic conditions (Lieser and Bauscher, 1987). TcO_4^- is
46 expected to be environmentally mobile in aerobic soils because it is not absorbed by negatively
47 charged exchange sites (Echevarria et al., 1998). Accordingly, K_d values (coefficient of
48 distribution between soil solid phase and soil solution) for TcO_4^- are very low and close to zero
49 (Echevarria et al., 1997; Sheppard et al., 1990). Several authors have reported that TcO_4^- does not
50 complex with humic acid in aerobic soils in laboratory studies (Takahashi et al., 1999; Van
51 Loon, 1984) and TcO_4^- readily moves with water flow in soil. However, Tc sorption on soil or
52 minerals has been reported under low redox conditions (Kumata and Vandergraaf, 1993;
53 Sheppard et al., 1990; Sheppard and Thibault, 1992; Tagami and Uchida, 1996). For example, an
54 investigation of technetium sorption properties in a large number of Canadian soils (Sheppard et
55 al., 1990) showed that in aerobic conditions Tc sorption increased slightly with organic matter
56 content.

57 Technetium is less available for plants in anaerobic soils than in aerobic soils (Sheppard et al.,
58 1990; Tagami and Uchida, 1997) probably due to the reduction of Tc(VII) to lower oxidation
59 states and the formation of less soluble species, such as TcO_2 (oxidation state +4). The reverse
60 process of TcO_2 oxidation is slow thereby limiting pertechnetate release into the soil solution

61 (Echevarria et al., 1997; Tagami, 2003; Tagami and Uchida, 1999). Much research has been
62 conducted on the behaviour of technetium in the context of rice production (Tagami and Uchida,
63 1997, 1998, 1999; Yanagisawa and Muramatsu, 1993;) as anaerobic conditions in paddy field
64 soils prevail for most of the harvesting period. In such waterlogged paddy fields, a large fraction
65 of technetium is converted into chemical species that are unlikely to be readily available to plant,
66 leading to its accumulation in soil.

67 Most available evidence suggests that ^{99}Tc bioavailability will largely depend on the anion
68 exchange capacity of soil, but experimental data to test this prediction are limited, especially in
69 field conditions. Transfer of Tc from soil to plants in laboratory conditions is generally higher
70 than that measured in the few reported field studies (Green et al., 1996; Hoffman et al., 1982;
71 Tagami et al., 2005). Bennett and Willey (2003) suggested that the differences between
72 laboratory and field data might be due to a prolonged period of contact of ^{99}Tc with soil in field
73 conditions, which were likely to include periods of anaerobic conditions leading to reduced
74 bioavailability of ^{99}Tc .

75 The transfer of radionuclides from soil to vegetation is normally quantified using the
76 Concentration Ratio (CR) which is defined as the radionuclide activity concentration in the crop
77 (dry or fresh weight) divided by the radionuclide concentration in soil (dry weight, 10 cm layer
78 for grass and 20 cm layer for other plants) at equilibrium. The International Atomic Energy
79 Agency has compiled CR reference values for many radionuclides (called transfer factors, TF),
80 including Tc (TRS 472, IAEA, 2010). Numerous studies have shown a wide variation in Tc
81 concentration ratios within and between plant species, as well as between the initial chemical
82 forms after contamination and for different time periods after contamination (termed “aging”).
83 The IAEA reports maximum CR values of ^{99}Tc in food crops and pasture vegetation ranging
84 from 1.4 to 470 (IAEA, 2010). The generally high CR values for Tc were attributed by Cataldo
85 et al. (1983) to the efficient absorption of $^{99}\text{TcO}_4^-$ by mechanisms in plants already present for
86 metabolism of essential nutrient elements. Echevarria et al. (1998) showed in a short term pot
87 experiment that an excess of NO_3^- in soil significantly decreased the transfer of $^{99}\text{TcO}_4^-$ to the
88 root as a result of a competition between these two anions for root uptake.

89 An early review by Bell et al (1988) reported that availability for plant uptake of ^{99}Tc is
90 generally higher in sandy soils than in clay soils. Consistent with this, in TRS 472 (IAEA,
91 2010), the CR values are generally higher for sandy soils than for loams, but few relevant data
92 are available.

93 There are large reported differences of CR values for Tc between crop plant species (Cataldo
94 et al., 1984; Garland et al., 1983; IAEA 2010). The highest observed transfer factors are for the
95 plant families Fabacea and Brassicacea; however, there were also large differences within these
96 plant families. Accumulation of ^{99}Tc by vegetative organs in plants has been reported to be
97 considerably higher than that by reproductive or storage organs (Bell et al., 1988; Dehut et al.,
98 1989; Murphy and Johnson, 1993). TcO_4^- is very mobile in the xylem network (Clarke et al.,
99 2012) and accumulates in chlorophyllian organs (ie leaves) where it would be reduced by
100 photosynthetic processes (Simonoff et al., 2003, and references therein) and bound to organic
101 compounds.

102 Technetium accumulation by plants is rapid and, when present as TcO_4^- , it readily moves to
103 above ground plant organs. For instance, about 80% (62-79%) of the initial ^{99}Tc content in silt
104 loam and silty-clay loam soils was taken up by ryegrass during a single growing period in a pot
105 experiment (Echevarria et al., 1997). Tc-99 uptake was related to biomass production and total
106 uptake by the aerial part of wheat in this experiment varied between 37-47 %.

107 Studies on changes with time in the plant uptake of TcO_4^- in both laboratory (e.g. Garten et
108 al., 1984; Mousny and Myttenaere, 1982) and field experiments (Garten et al., 1984,
109 Vandecasteele et al., 1989) have generally shown a notable decrease in observed CR values for
110 pasture from one harvest to the next. Aging of ^{99}Tc in loamy sand and subsoil over 100 days
111 resulted in a decrease of CR for wild grasses by factors of 1.5 to 5.1 in a laboratory study by
112 Cataldo (1979). A reduced availability of Tc with time was also observed by Garten et al. (1984)
113 following application of $^{95\text{m}}\text{TcO}_4^-$ to a field plot and to pots with a Captina silt loam soil: The
114 CaCl_2 -extractable $^{95\text{m}}\text{Tc}$ quantities declined with time (over a six month period) to less than 10%
115 ($7\pm 3\%$ for field soil; $9\pm 3\%$ for undisturbed soil in large pots; $6\pm 2\%$ for sieved soil in large pots;
116 $3.6\pm 0.3\%$ for sieved soil in small pots) of the applied Tc for both laboratory and field
117 experiments. Most of the reported data on soil-to-plant transfer of technetium have been obtained
118 under laboratory conditions over only a few growing seasons at most.

119 The extremely high mobility of Tc as a pertechnetate chemical species is an important issue
120 for radioprotection purpose due to its high rate of transfer in the food chain. The CR observed
121 values needs to be better discriminated according to environmental factors as they play a major
122 role in Tc distribution. Aging parameter and differences between field and controlled laboratory
123 conditions issues also needs to be addressed. Our study aims to quantify the distribution of ^{99}Tc
124 in the profile of four different soil types and the uptake of $^{99}\text{TcO}_4^-$ by different food crops

125 categories (leafy veg., root veg., tuber, cereal, leguminous) over several consecutive growing
126 periods in field conditions, and over long time periods (years). The use of field conditions and
127 the duration of the experiment make it possible to take into account the interaction of
128 environmental variables and to acquire CR values representative of real agricultural conditions.

129 The following set of hypotheses have been used to structure this study: (i) ^{99}Tc will be lost
130 rapidly from the upper soil horizons for a range of soil types (ii) ^{99}Tc transfer to plants will vary
131 over a range of soil types, (iii) ^{99}Tc uptake will vary considerably between different plant crops
132 and (iv) Tc uptake into plants will decrease rapidly with time in field conditions.

133

134 1 MATERIALS AND METHODS

135 The experiments were carried out at the experimental site, described in earlier papers on
136 iodine and chlorine (Kashparov et al., 2005a, 2005b), which is located in the Chernobyl
137 Exclusion zone. Local soil contamination with ^{99}Tc due to the Chernobyl deposition was about
138 400 Bq m^{-2} (1997, sampling depth of 30 cm). Four different, previously uncontaminated, soil
139 types (imported from other areas in Ukraine) placed in two growing containers per soil type were
140 used in this study of the root uptake of ^{99}Tc by different agricultural crops (Fig. S1). Each
141 container was $2 \times 2 \text{ m}^2$ wide and the depth was 0.5 m. According to FAO (IUSS Working Group
142 WRB, 2006), the four soil types are classified as Podzoluvisol, Greyzem, Phaeozem and
143 Chernozem. They were taken from the 20-cm arable layer of agricultural lands in various regions
144 of Ukraine. Such soil types are characterized by a large variation in agrochemical properties
145 (Table 1) which would be expected to lead to considerable variation in ^{99}Tc root uptake with soil
146 type. Initial activity concentrations of ^{99}Tc in the soils were below detection limit (0.1 Bq kg^{-1})

147 “Table 1 is about here”

148

149 The radionuclide for these experiments was obtained from V.G. Kholopin Radium Institute
150 (Russia) in a form of solid potassium pertechnetate ($\text{K}^{99}\text{TcO}_4$). This salt was dissolved in 1M
151 nitric acid to obtain 216 ml of a stock radionuclide solution (Tc oxidation state +7) with 10 kBq
152 ml^{-1} . To obtain a ^{99}Tc solution an aliquot of 14 ml of the stock solution was diluted with tap
153 water to a volume of 10 litres. Eight equal portions of 10 litres of the ^{99}Tc solution were prepared
154 (Fig. S2). The first administration of ^{99}Tc occurred on 16 May 2005. The upper 20-cm layers of
155 soil in each container were carefully mixed and 10 litres of the ^{99}Tc solution were sprayed onto

156 the 4 m² container surface using a special garden-watering tool. The ⁹⁹Tc activity concentration
157 in the 20-cm soil layer was nominally about 160 Bq·kg⁻¹ dw (0.26 µg·kg⁻¹); but varied within the
158 range of 120-180 Bq·kg⁻¹ dw due to the different soil densities in the containers. The soils were
159 then fertilized with inorganic fertilizer (NPK 16:16:16) added in quantities of 60 g m⁻² into
160 Podzoluvisol and Chernozem and 50 g m⁻² into Greyzem and Phaeozem. Then, careful triple
161 mixing was carried out to the same depth to achieve a uniform spatial distribution of ⁹⁹Tc and
162 fertilizer within the arable layer in each container. The final density of contamination with ⁹⁹Tc
163 within each container was 35 kBq·m⁻².

164 The crops were then planted on the same day as the ⁹⁹Tc was administered according to the
165 following scheme for each of the eight containers (Fig. S3):

166 Radish (*Raphanus sativus* L. convar. *radicula.*, French Breakfast variety) seeds were sown over
167 2 m² at a depth of 1-2 cm in 4 rows (inter-row distance ≈ 20 cm);

168 Four potato tubers (*Solanum tuberosum* L.) were planted between the radish rows;

169 Lettuce (*Lactuca sativa* L.) seeds were sown in containers over 2 m² at a depth of 1-2 cm in 4
170 rows (inter-row distance ≈ 20 cm);

171 Beans (*Phaseolus vulgaris* L.) seeds were planted in 2 m² at a depth of 4-5 cm in 2 rows (inter-
172 row distance ≈ 50 cm, distance between seeds in the row ≈ 10 cm).

173 Wheat (*Triticum aestivum* L.) was sown in 2 m² at a depth of 5-6 cm according to agronomic
174 recommendations for the amount of seeds.

175 About one year later ⁹⁹Tc (30.6 kBq·m⁻²) was again added onto the container soils on 27 April
176 2006 in a similar manner as that described above. The reason for two consecutive applications
177 of ⁹⁹Tc was that at the beginning of the experiment we were not sure that measureable activity
178 concentrations of ⁹⁹Tc would remain in the root layer in the second year. Crops were planted
179 after fertilization and homogenization of the soils in the same quantities as during the previous
180 growing season, but with crop rotation. Beans were planted on 22 May when the temperature
181 increased to that recommended for this crop.

182 The third stage of the experiment started on 18 April 2007. The contaminated soil within the
183 containers was dug up, fertilized and only two of the crops were planted (summer wheat and
184 potato). The areas of planting therefore increased to 4 m² for wheat and 2 m² for potato.

185 After three years of the experiment the containers were left fallow for a period of about 5
186 years without further treatment before wheat was planted again. During the fallow period
187 different natural graminaceous plant species typical for each soil type colonized the experimental
188 containers. The final stage of the experiment started on 18 April 2012. After digging which
189 incorporated the currently growing vegetation into the soil, followed by homogenising and
190 fertilization (at rates used previously), the summer wheat was sown as before (over 4 m²). The
191 experiment was repeated in 2013 and 2014 with the same treatment applied.

192 **Sampling procedures**

193 Crops and soils were sampled at the normal time of harvesting of the mature agricultural
194 species. Vegetables and wheat were harvested in the following sequence (Table 2).

195 From each container contaminated with ⁹⁹Tc only the edible part of harvested vegetables was
196 taken for analysis. Each container yielded one sample per crop type giving four replicates. Wheat
197 stalks were cut down and sheaved. The sheaves were then threshed in the laboratory by hand and
198 samples of straw and grain were collected for treatment and measurement. Soil samples were
199 collected in the containers under each species using a cylindrical sampler (diameter of 3.7cm).
200 Soil samples in each container were collected by the “envelope” method (5 cores) down to a
201 depth of 20 cm. In addition, after the first contamination procedure and at the end of the growing
202 periods, different layers of soil were collected from the containers contaminated with ⁹⁹Tc. The
203 soil samples were taken with a tube-type sampler (Ø 5 cm) to the depth of 30 cm and then each
204 core was divided into 10-cm segments. Soil layer samples were also collected before the second
205 administration of ⁹⁹Tc.

206 **Tc extraction methods**

207 Separation of ⁹⁹Tc from soil samples was carried out using TEVA discs (Eichrom
208 Technology, Inc.). The soil samples were dried in an electrical oven at 105°C to a constant
209 weight. Then they were carefully mixed and sieved through a 1 mm sieve. The four studied soils
210 were weighed (100-200 g) into appropriate quartz crucibles and ashed in a muffle furnace at
211 450°C for 12 hours to combust the organic matter. Two sub-samples were prepared from each
212 soil. Before ashing one sample was spiked with 10 Bq of ⁹⁹Tc for the chemical recovery
213 determination. After cooling the sample was transferred into a 1000 mL glass beaker and 500 mL
214 of 1M HNO₃ was added. Then ⁹⁹Tc was leached from the sample on a hotplate magnetic stirrer at
215 80°C for 4 hours and left overnight. Residual solid matter from the suspension was removed by
216 filtration through a paper filter. The solid residue was discharged. The extract was placed into a

217 2000 mL glass beaker and 20 mL of 30% H₂O₂ was added. The extract was diluted with water
218 until a final sample volume of approximately 2 L was achieved and its acidity was reduced to
219 pH=2 using ammonium hydroxide. The sample was heated to about 90°C for 1 hour to oxidize
220 Tc(IV) to Tc (VII), to destroy residual organic matter and excess H₂O₂. After cooling to room
221 temperature the sample solution was filtered through the TEVA disc by gravity. Tc-99 was
222 measured by liquid scintillation counting by adding the disc directly to the scintillation cocktail
223 (OptiPhase HiSafe, PerkinElmer).

224 Initial treatment of the plant samples varied for different species. All plant samples were
225 carefully washed, peeled (potato), chopped (radish, wheat straw) and dried in an electrical oven
226 at 105°C to a constant weight. Subsequently, all samples were ground and two aliquots (2-20 g)
227 were collected for further radiochemical ⁹⁹Tc extraction procedures, which were the same as
228 those given for soil except the final sample volume, which for the plant sub-samples was ca. 1 L.
229 The aliquots were increased to ca. 200 g for wheat grain samples that collected in 2012-2014.

230 **Measurement of ⁹⁹Tc activity concentration**

231 The ⁹⁹Tc activity concentration in soil and plant samples was measured using a liquid
232 scintillation counting system with a MARK-IIIM liquid scintillation counter (Tracor Analytic
233 Inc., USA). OptiPhase HiSafe was used as the scintillation fluid. For our measurement scheme
234 the minimum detectable activity was estimated to be 0.1 Bq. Each sample was analyzed with and
235 without a ⁹⁹Tc spike to determine chemical recovery. Total chemical recoveries of Tc in the used
236 extraction techniques varied in the range 65-97% and activities of the measured samples were
237 corrected to 100%.

238 All reported specific activities and derivative values were calculated on a dry weight (dw)
239 basis.

240 **Statistical treatment of the data**

241 Values of CR and activity concentrations of ⁹⁹Tc in soil are given as arithmetic means and
242 standard deviation of the four replicas. One-way analysis of variance was performed on the
243 natural logarithms of the data at a significance level of 0.05. The Tukey test was then used for
244 comparison of means.

245

246 2 RESULTS AND DISCUSSION

247

248 Mobility / dynamics of ⁹⁹Tc in the soil profiles

249 Taking into account the chemical properties of Tc (Leiser and Bauscher, 1987) and its
250 behaviour in aerobic agricultural soils (Bennett and Willey, 2003) we assumed that at the early
251 stage of our experiments that ⁹⁹Tc pertechnetate ion applied to the soil initially remained in this
252 form. TcO₄⁻ is highly soluble and weakly sorbs onto soil particles (Sheppard et al., 1990). TcO₄⁻
253 was probably initially not complexed with humic acids and other dissolved organics (Takahashi
254 et al., 1999; Van Loon et al., 1984). Therefore, we expected that ⁹⁹Tc would be highly mobile in
255 the experimental arable soil layers and would migrate in soil with the soil water.

256 Soil layer sampling was performed one week after ⁹⁹Tc application to determine the initial
257 ⁹⁹Tc distribution in the arable layer of soils. At this stage most of the ⁹⁹Tc in all soil containers
258 was still present in the upper 10-cm layer (Fig. 1, Table S1), but there had already been some
259 migration into the 10-20 and the 20-30 cm layers in all four soil types. Subsequent soil sampling
260 at the end of the growing season on 1 September 2005 showed a rapid vertical migration of ⁹⁹Tc
261 in the soil profiles (Fig. 1, Table S1) with most of the ⁹⁹Tc below 10 cm soil depth. Since the
262 beginning of the growing period ⁹⁹Tc had redistributed more uniformly between the soil layers.

263 “Figure 1 is about here”

264 The subsequent soil sampling in spring 2006 (one year after ⁹⁹Tc application) showed that
265 vertical migration of ⁹⁹Tc with soil water played a key role in decreasing the amount of ⁹⁹Tc in
266 the upper arable soil layers (Fig.2, Table S1). One year after ⁹⁹Tc administration, the inventory of
267 ⁹⁹Tc in the upper 30-cm soil layers decreased by approximately 25-50% for all soils giving an
268 effective rate of removal of 0.3-0.7 y⁻¹. Rapid losses of pertechnetate from a smaller 15-cm root
269 zone were predicted by Baes (1979) based on factors such as the velocity of vertical water
270 movement in the soil profile, the depth of the soil root zone, the soil bulk density, soil water
271 content and values of K_d. He theoretically estimated a median leaching rate of TcO₄⁻ of 2.6 y⁻¹.
272 Rapid downward migration of ^{95m}TcO₄⁻ in a silt loam was also observed in a 7-month field
273 experiment by Hoffman (1982) who estimated an effective rate of removal of ⁹⁹Tc from the 0-15
274 cm root zone of 1.3 y⁻¹.

275 In the spring of 2006, additional ⁹⁹Tc was administered to the soils and the ⁹⁹Tc activity
276 concentration in the arable soil layer therefore increased by approximately 100 Bq kg⁻¹ dw. Soil
277 layer sampling one year after the second ⁹⁹Tc addition (Fig. 2, Table S1) confirmed that ⁹⁹Tc had

278 again migrated extensively down the soil profiles, and was measurable in the 30-40 cm depth soil
279 layer in three of the soil types.

280 “Figure 2 is about here”

281 Echevarria et al. (1997) carried out extractions of ^{99}Tc immediately after contamination of
282 silt loam and silty-clay loam soils in lab experiments and found that the initially available
283 fraction of ^{99}Tc was up to 96% of that applied. Therefore, although we did not measure the
284 soluble fractions immediately after administration we anticipate that it would have been rather
285 high. To estimate the amount of ^{99}Tc present as an available fraction in the arable soil layers (20
286 cm depth) at the end of the second growing season a simple water extraction (fresh soil to
287 deionized water ratio of 1:5) was carried out. The water-soluble fractions accounted for 21 to 30
288 % of ^{99}Tc residues in arable layers for all soils (22±4% in Podzoluvisol, 30±8% in Greyzem,
289 21±4% in Phaeozem and 28±7% in Chernozem). Therefore, the available fraction of ^{99}Tc
290 remaining in the soils had probably considerably decreased since the beginning of the
291 experiment. For the studied soil types, the impact of "aging" of Tc was similar ($p>0.05$) for all
292 soil types despite their differing agrochemical characteristics (Table 1). The same experiment
293 was carried out in 2014 showing a significant ($p<0.01$) decrease in the water-soluble fraction of
294 ^{99}Tc in all soil types (8±2% in Podzoluvisol, 4±1% in Greyzem, 5±1% in Phaeozem, and 9±2%
295 in Chernozem).

296 Sampling in 2012 showed that TcO_4^- was still measurable in the arable soil layers 6-7 years
297 after initial soil contamination (Table 2). Between 11-18% of the total ^{99}Tc added in the two
298 stages remained in the upper 20 cm layers of the soils (Podzoluvisol – 12±2 %; Greyzem - 12±2
299 %; Phaeozem - 18±3 %; Chernozem – 11±2%). The ^{99}Tc activity concentration in all the soil
300 types was similar except for Phaeozem where it was higher ($p<0.05$). The period of half-removal
301 of ^{99}Tc from the 20-cm arable soil layer due to vertical migration and transfer to plants was 2-3
302 years.

303 Subsequent soil samplings in 2013 and 2014 demonstrated that contamination of arable soil
304 horizons had not changed significantly since 2012 (Table 2). This observation suggests that
305 technetium had reached an equilibrium state in the soil.

306 The content of TcO_4^- in the arable soil layer is mainly controlled by three processes:
307 downward migration with soil water, Tc(VII) reduction to a lower, less mobile oxidation state
308 and uptake by plants. In the case of permanent agricultural use of land a significant part of TcO_4^-

309 can be removed by crops. In laboratory conditions, ^{99}Tc removal by plants during the first season
310 exceeded 90% of an initially applied spike of TcO_4^- (Sheppard et al., 1983).

311 “Table 2 is about here”

312

313 In contrast, in field conditions a significant fraction of the ^{99}Tc was still present in the soil
314 arable layer. We suggest that plants may have played an important role in retaining ^{99}Tc in the
315 upper part of soils for the long duration of the experiment. A possible mechanism is that ^{99}Tc is
316 fixed within residues of plant roots (as shown by the radish), stubble, and leaves in the soil.
317 When contaminated fields are not used for crop production, the establishment of natural
318 vegetation (which has relatively high CR values) will accumulate ^{99}Tc and retain it in gradually
319 decomposing vegetative material in soil in a similar manner to that in crops. Further analysis
320 showed that contamination of decomposing natural vegetation growing in the experimental
321 containers during the fallow period, before soil treatment in spring 2012 varied from 30 to 40 Bq
322 m^{-2} . The same retention in the arable layer of soil has also been observed for chlorine
323 (Kashparov et al., 2005b). However, in contrast to technetium, which can be reduced in soil and
324 can form less mobile compounds, retention of chlorine in organic material such as decomposing
325 vegetation is the most feasible mechanism in the top soil layer.

326 Such a proposed behaviour of ^{99}Tc in soil complicates the estimation of its bioavailability in
327 terms of CR for fresh contamination because activity concentrations in soil arable layers would
328 change with time during the growing season due to vertical migration to deeper soil layers,
329 making the soil activity concentrations at the end of the vegetation period much lower than those
330 at the beginning (Fig.1). The concentration ratio of ^{99}Tc derived from its activity concentration in
331 soil at harvesting time may be overestimated since radionuclide uptake from soil to plant occurs
332 over the entire growing period (Table S4). To prevent such overestimations in determining the
333 CR values for fresh deposition (2005-2007) we used average values of the ^{99}Tc activity
334 concentration in the soils. The average value was determined as the arithmetic mean of the ^{99}Tc
335 activity concentrations in soil at the beginning and at the end vegetation period of each
336 individual crop (Table 2).

337 For aged deposition, when equilibrium conditions in soil-plant system were reached (2012-
338 2014), CR values were determined using the measured ^{99}Tc activity concentration in the soils
339 when harvesting occurred. There was no significance difference in ^{99}Tc activity concentration in
340 the same soil over this period thereby confirming that equilibrium had occurred.

341 **Variation in ⁹⁹Tc plant uptake with soil type in field conditions**

342 CR is usually calculated using soil measurements at harvesting time, but because Tc (and Cl)
343 are highly mobile, the CR measured at this time would be very conservative (as shown for Cl by
344 Kashparov et al. 2005b). CR is intended to represent the distribution between soil and plant at
345 equilibrium and this criterion cannot be reached during a limited vegetation growth period after
346 contamination occurred for highly mobile elements such as Tc. Therefore, in this study soil-to-
347 crop transfer of recently deposited ⁹⁹Tc (2005-2007) was characterized by CR values for the
348 harvested crop (on a dry weight basis) and a 20 cm soil depth measured both at the beginning
349 and at the end of each growing season and then averaged. For more aged deposits (2012-2014)
350 the CR values were calculated using data on the activity concentration of ⁹⁹Tc in soils at
351 harvesting time. We have calculated soil-to-plant transfer of ⁹⁹Tc during 2005-2007 and 2012-
352 2014 for the four soil types and the different crops grown. All data was collected on a plant dry
353 weight basis at the time of harvesting. The data can be recalculated to a fresh weight basis for the
354 crops using the corresponding ratio for dry to fresh weight for each crop of 20±3 for radish roots,
355 19±2 for lettuce leaves and 5±1 for beans pods (Kashparov et al., 2005b). Estimated CR values
356 for the various crops cultivated on the studied soil types are presented in Table 3. CR values for
357 radish roots and lettuce were considerably higher than those for the other crops measured.

358 In our experiment the radionuclide was applied twice during the first two years. Therefore, the
359 CR values obtained in the first year characterize the ⁹⁹Tc uptake to plants taking into account its
360 aging during the vegetation period. The CR values for the second year reflect the uptake of the
361 bioavailable fraction of ⁹⁹Tc remaining in the root-inhabited soil layer from the first year and of
362 the radionuclide administered at the beginning of the new vegetation period.

363 Although our study included a wide variability of soil properties (Table 1) there was little
364 evidence of dependence of technetium CR on soil type observed for the first three years of the
365 experiment (Table 3), especially in the first year after ⁹⁹Tc administration. The transfer of ⁹⁹Tc
366 into agricultural crops generally declined with time.

367 **Effect of plant type on transfer**

368 Comparisons of the CR values recorded in our experiments with reported values from
369 other studies are given below. Clearly the relevance of the difference for predictions would
370 depend on the timing of any contamination event and subsequent harvesting.

371 Transfers of ^{99}Tc into **radish roots** grown on Podzoluvisol and Greyzem over two growing
372 seasons were similar between soil types ($p>0.05$) and, considering the uncertainties of
373 measurement, could be characterized by a CR value of about 120 (Table 3). The uptake of ^{99}Tc
374 into radish root grown on Chernozem and Phaeozem soils were similar in each growing season
375 ($p>0.05$ for 2005 and $p>0.05$ for 2006), and was significantly lower in 2006 compared with 2005
376 (CR values declining two fold). The IAEA Technical Reports Series 472 (IAEA, 2010) gives a
377 CR range for Tc of 14-79 for root crops so the study values for radish roots were either at the
378 upper edge of the range given in TRS-472 or higher. The maximum uptake of ^{99}Tc by radish
379 roots over one growing season was roughly 3 % of the initial ^{99}Tc content in the soil profile
380 (Table S2).

381 Several studies have previously reported the high root uptake of Tc by leafy vegetables
382 (Sheppard et al, 1983; Garten et al., 1986). In our study **Lettuce** grown on Phaeozem and
383 Chernozem contaminated with ^{99}Tc in 2005 also had the highest CR values amongst the crops
384 studied at 150 and 210, respectively (Table 3). Statistically significant differences between the
385 different soil type values were not observed ($p>0.05$). In the subsequent 2006 growing season
386 there was a decreased ^{99}Tc uptake by lettuce with CR values ranging from 80-100. Lettuce
387 grown on Greyzem in 2006 had a CR value of 60. There was no significant difference between
388 Phaeozem and Greyzem ($p>0.05$). All CR values for lettuce derived in our study were within the
389 range for Tc given in IAEA TRS 472 for leafy vegetables (IAEA, 2010). The maximum uptake
390 of ^{99}Tc by lettuce over one growing season was roughly 10% of the initial ^{99}Tc content in the soil
391 profile (Table S2), which is consistent with previously reported higher activity concentrations of
392 ^{99}Tc in leaves compared with reproductive organs (Bell et al., 1988; Dehut et al., 1989; Murphy
393 and Johnson, 1993).

394 “Table 3 is about here”

395 In 2005, the ^{99}Tc activity concentration in **green beans** ranged from 0.6-2.2 $\text{kBq}\cdot\text{kg}^{-1}$ dw over
396 the four soil types and was highest for Chernozem and lowest for Podzoluvisol. CR values
397 ranged from 7 ± 2 to 15 ± 4 , with a statistically significant overall difference between all four soil
398 types ($p<0.05$). In contrast, in 2006 the highest uptake of ^{99}Tc from soil was on Podzoluvisol
399 (Table 3). The mean CR value for Podzoluvisol of 80 ± 20 was one order of magnitude higher
400 than that observed in previous year. Similarly, the CR of 30 ± 10 for green bean grown on
401 Greyzem in 2006, was considerably higher than that obtained in the first growing season. In
402 contrast, the transfer of ^{99}Tc into green bean on Phaeozem and Chernozem decreased several

403 times in 2006 compared with 2005. During the second growing season the yield of beans on
404 Podzoluvisol and Greyzem was low (only a few bushes grew on these soils) and the observed
405 differences in ^{99}Tc contents between plants from different soils could be due to the local
406 heterogeneity in ^{99}Tc distribution in these soils and/or relatively high soil adhesion on the low
407 biomass of the plants.

408 We have only identified one study of the root uptake of Tc into beans by Green et al., (1995)
409 in the available literature. This field investigation, which involved aged deposits of ^{99}Tc from a
410 marine source origination in discharges from Sellafield, reported a CR value of 1.2 for French
411 beans. The values from our study were considerably higher than that obtained by Green et al.
412 (1995) probably due to differences between the ages of the ^{99}Tc deposits in the soils. The CR
413 values in the present study are close to those obtained by Choi et al. (2014) in lab experiments
414 for soybean which belong to the same family of *Leguminosae* as the common bean. Authors
415 reported a CR value of ca. 11 for soybean pods. The maximum uptake of ^{99}Tc by green beans
416 over one growing season was roughly 0.5 % of the initial ^{99}Tc content in the soil profile (Table
417 S2).

418 The activity concentration of ^{99}Tc in the peeled **potato tubers** was two orders of magnitude
419 lower than in the other vegetable crops. CR values of about 2 were observed in 2005 for all soil
420 types (Table 3). Similarly, to most other crops, ^{99}Tc uptake into potato tubers was approximately
421 two times lower during the second and the third growing seasons. CR values in the range of 0.6-
422 1.4 were obtained for all soils in the second growing season. No significant differences between
423 ^{99}Tc transfer into potato tubers grown on the same soil type in the second and the third growing
424 seasons were observed ($p > 0.05$). CR values for Phaeozem for the last growing season (2007)
425 were significantly lower ($p < 0.05$) than those for the other soil types. Few data have been
426 published on the uptake of Tc into potato tubers (see review of Ewers et al., 2011). Green et al.
427 (1995) reported CR values in the range of 0.1-0.7 in a field study with aged technetium deposits
428 due to Sellafield discharges. The maximum uptake of ^{99}Tc by potato tubers over one growing
429 season was about 1 % of the initial ^{99}Tc content in the soil profile (Table S2).

430 Data on transfer of ^{99}Tc into **summer wheat** were obtained for six harvests over a long period
431 of time giving unique long term information on the time dependent uptake of ^{99}Tc . The transfer
432 of ^{99}Tc into wheat grain and straw during the first growing season (94 days) did not differ
433 significantly between the soil types ($p > 0.05$). CR values were 0.5-0.8 for grain and 20-for straw

434 (Table 3). Data obtained for the second and the third yields of wheat did not show a considerable
435 reduction of technetium availability in all soil types (Fig. 3).

436 The CR values for **wheat grain** in 2006 (Table 3) did not differ significantly at the 5% level
437 between the soil types ($p>0.05$) except Podzoluvisol and Phaeozem pair. Furthermore, the CR
438 values for wheat grain in 2007 did not show a notable change of ^{99}Tc availability compared with
439 2005. Thus, technetium transfer into wheat grain did not noticeably decline for the field
440 conditions of our experiment over a three year period. The CR values observed in our study for
441 fresh deposition matched the range of CR values for cereal grain given in the IAEA review
442 (IAEA, 2010), but were considerably higher than the CR values of 0.02-0.2 obtained for wheat
443 grain grown on various soil types by Eriksson (1982) for 2 year old contamination.

444 For the long term measurements of transfer conducted in 2012-2014 the plant uptake of ^{99}Tc
445 decreased significantly ($p<0.0001$) since 2007 in all soils used in this study (Fig. 3). The CR for
446 wheat grain in 2012-2014 varied from 0.02 ± 0.01 for Phaeozem to 0.15 ± 0.04 for Podzoluvisol.
447 The highest uptake of ^{99}Tc from soil was on Podzoluvisol with CR values (Table 3) that did not
448 differ significantly over the 3-year period ($p>0.05$). The lowest uptake of the radionuclide with
449 no significant difference among the period ($p>0.05$), was on Phaeozem. Uptake of ^{99}Tc from
450 Chernozem and Greyzem in 2012 were higher comparing with that in 2013-2014. The CR
451 values for wheat grain in 2014 comparing with 2007 declined by 8 to 55 fold suggesting that the
452 reduction of $^{99}\text{TcO}_4^-$ to lower oxidation states with lower bioavailability in field conditions
453 occurs slowly.

454 “Figure 3 is about here”

455 CR values for **wheat straw** were significantly higher ($p<0.0001$) than for wheat grain (Table
456 3). The concentration factors for the vegetative parts of wheat were about two orders of
457 magnitude more than those for grain. The relatively low uptake by the seeds of crops in our study
458 has also been reported in other studies (Murphy and Johnson, 1993; Vandecasteele et al., 1989).
459 Partitioning of ^{99}Tc accumulated between wheat straw and grains was similar in the plants grown
460 in the field to that observed in laboratory experiments (Echevarria et al., 1997; Murphy and
461 Johnson, 1993). The maximum uptake of ^{99}Tc by wheat straw over one growing season was
462 roughly 5 % of the initial ^{99}Tc content in the soil profile (Table S2).

463 **Time dependency**

464 In general, the dynamics of ^{99}Tc bioavailability in the experimental field conditions was
465 complex and could not be explained solely by Tc aging in soil, its vertical migration out of the
466 rooting zone of the soil and uptake by plants. Taking into account data observed in 2012-2014
467 we estimated that about 80% of initially added Tc moved out of the 0-20 cm root zone due to
468 vertical migration and via harvested plants. The order of magnitude decrease in CR values for
469 wheat grain in 2012 since the first $^{99}\text{TcO}_4^-$ administration (2005) suggests that about 90% of ^{99}Tc
470 have been transformed to forms that were unavailable for plant uptake.

471 The Tc CR values for the crops studied were several times lower than those that had been
472 obtained in the same conditions of the field experiments for chlorine (Kashparov et al., 2005b).
473 Experimental data obtained by Shaw (2004) confirm the higher bioavailability of ^{36}Cl compared
474 with ^{99}Tc .

475 **CONCLUSIONS**

476 The main result of the study was revealing the long-term dynamics of ^{99}Tc in soils. It has been
477 shown that, despite the high initial mobility of technetium in soil, a significant part of the
478 radionuclide remains in the root layer in the long term. We assume that the radionuclide reaches
479 an equilibrium in the root layer of soil in a few years after application (deposition) and that
480 further decrease in its bioavailability is slow.

481 **Mobility of Tc in the soil profile**

482 *Hypothesis: ^{99}Tc will be lost rapidly from the upper soil horizons for a range of soil types.*
483 The decrease of ^{99}Tc activity concentrations in the upper 30-cm layer of soil one year after
484 administration varied from 25% to 50% of its initial content. Vertical migration of ^{99}Tc with soil
485 water and, to a varying but lesser extent, plant uptake played important roles in ^{99}Tc removal
486 from the upper soil layer. However, after 6-7 years of soil contamination with ^{99}Tc , 11-18 % of
487 the total ^{99}Tc added in the two stages remained in the upper 20 cm layers of the soils,
488 corresponding to a period of half-removal of 2-3 years (rates of removal – 0.35-0.23 years⁻¹).
489 These observed values are an order of magnitude lower than the median value of 2.6 years⁻¹
490 estimated by Baes (1979) for the 0-15 cm soil layer using a model of the radionuclide movement
491 in soil with percolating water. The range of values in Baes (1979) study covers 3 orders of
492 magnitude depending on soil parameters and K_d values. Baes' estimate is conservative because it
493 does not take into account Tc retention in the root zone by plants. Similarly, the value estimated
494 by Hoffman (1982) is several times higher than in our experiment, although it was derived in a
495 short term field experiment for the 0-15 cm soil layer.

496 **Plant uptake variation with soil type in field conditions**

497 *Hypothesis: ⁹⁹Tc transfer to plants will vary over a range of soil types.* Tc accumulation by
498 plants did not differ between soil types for the first two years after ⁹⁹Tc administration. A reason
499 for the lack of difference could be the low rate of reduction of Tc(VII) to Tc(IV) under the
500 experimental conditions. If this was the case, the difference that might be expected due to soil
501 type may have been small compared with the possible influence of variation in environmental
502 factors such as temperature and precipitation rate. Clearly, further experimental measurements
503 would be needed to address these issues.

504 In subsequent years, when additional ⁹⁹Tc was not applied, accumulation of ⁹⁹Tc by the
505 agricultural crops was higher for Podzoluvisol and Chernozem. Seven years after the last
506 administration of ⁹⁹Tc (2013) the biggest difference in CR values for summer wheat grain of
507 about 9 fold, was observed for Podzoluvisol and Phaeozem.

508 **Effect of plant type on transfer**

509 *Hypothesis: ⁹⁹Tc uptake will vary considerably between different plant crops.* Under the
510 experimental conditions, lettuce leaves and radish roots had the highest root uptake of ⁹⁹Tc added
511 as pertechnetate. The CR for radish roots were in the range of 80-270 for freshly contaminated
512 soils whilst those for lettuce leaves were in the range of 120-330. Uptake of ⁹⁹Tc in the potato
513 tubers (CR range of 0.4-2.9) was two orders of magnitude lower than that in the two vegetables.
514 Accumulation of ⁹⁹Tc by summer wheat grain was lowest and characterized by a CR range of
515 0.9 ± 0.3 over the first 1-2 years.

516 Paired Tukey tests showed that uptake between plant types in 2005 was significantly different
517 ($p > 0.05$) from the same soil type except for lettuce and radish. In 2006, CR values for all crops
518 growing on the same soil were also significantly different ($p > 0.05$) except those for radish and
519 green beans on Podzoluvisol, and lettuce and radish on all other soils. In 2007, the uptake
520 between potato tubers and wheat grain growing on the same soil types were significantly
521 different ($p > 0.05$) except for the Podzoluvisol.

522 **Time dependency**

523 *Hypothesis: ⁹⁹Tc uptake into plants will decrease rapidly with time in field conditions.* This
524 was correct for summer wheat grain. Over a long period of about 6 years, part of the ⁹⁹TcO₄⁻ was
525 converted to an immobile form resulting in a significant decrease in its availability for root

526 uptake. In 2012-2014, the CR values for wheat grain were one order of magnitude lower than
527 those observed for fresh contamination.

528 **Acknowledgements**

529 The presented research was carried out within the framework of the MITRA-UA Project (a
530 contract between IRSN and UIAR NUBiP of Ukraine “Studies on radionuclides transfer in
531 agricultural ecosystem”, 31001327). The authors express their gratitude to IRSN for the support
532 of this work. CEH inputs were contributed under co-operation within the MODARIA
533 programme of the IAEA.

534 **References**

- 535 Baes, C. F. III., 1979. The soil loss constant A, due to leaching from soils. p. 85-92. In: F. O.
536 Hoffman and C. F. Baes, III (Eds.) A statistical analysis of selected parameters for predicting
537 food chain transport and internal dose of radionuclides. Oak Ridge Natl. Lab., Pub.
538 ORNL/NUREG/TM282. Natl. Tech. Inf. Serv., Springfield, Va.
- 539 Bell, J.N., Minski, M.J., Grogan, H.A., 1988. Plant uptake of radionuclides. *Soil use and*
540 *Management* 4, 76–84. <https://doi.org/10.1111/j.1475-2743.1988.tb00740.x>
- 541 Bennett, R., Willey, N., 2003. Soil availability, plant uptake and soil to plant transfer of ⁹⁹Tc – A
542 review. *Journal of Environment Radioactivity* 65, 215–231. [https://doi.org/10.1016/S0265-](https://doi.org/10.1016/S0265-931X(02)00098-X)
543 [931X\(02\)00098-X](https://doi.org/10.1016/S0265-931X(02)00098-X)
- 544 Cataldo, D. A., 1979. Behavior of Technetium and Iodine in a Hanford Sand and Associated
545 Subsoil: Influence of Soil Aging on Uptake by Cheatgrass and Tumbleweed. Pacific Northwest
546 Laboratory. PNL-2740. March 1979. [WWW Document]. URL
547 https://digital.library.unt.edu/ark:/67531/metadc1111417/m2/1/high_res_d/6230907.pdf
- 548 Cataldo, D.A., Wildung, R.E., Garland, T.R., 1983. Root absorption and transport behavior of
549 technetium in soybean. *Plant physiology* 73, 849–853. <https://doi.org/10.1104/pp.73.3.849>
- 550 Cataldo, D.A., Garland, T.R., Wildung, R.E., 1984. Plant root absorption and metabolic fate of
551 technetium in plants. In: Desmet, G., Myttenaere, C. (Eds.), *Technetium in the Environment*.
552 Elsevier, London. https://doi.org/10.1007/978-94-009-4189-2_22
- 553 Yong-Ho Choi, Kwang-Muk Lim, In Jun, Byung-Ho Kim, Dong-Kwon Keum, In-Gyu Kim,
554 2014. Soil-to-soybean transfer of ⁹⁹Tc and its underground distribution in differently
555 contaminated upland soils. *Journal of Environmental Radioactivity*, 132, 57-64
556 <https://doi.org/10.1016/j.jenvrad.2014.01.016>
- 557 Clarke, S.J., Rogiers, S.Y., Currie, G.M., 2012. Long-distance transport of pertechnetate in the
558 moonflower (*Ipomoea alba*). *Journal of Environment Radioactivity* 103, 54–58.
559 <https://doi.org/10.1016/j.jenvrad.2011.08.012>
- 560 Curtis, D., Fabryka-Martin, J., Dixon, P., Cramer, J., 1999. Nature’s uncommon elements:
561 plutonium and technetium. *Geochimica et Cosmochimica Acta* 63, 275–285.
562 [https://doi.org/10.1016/S0016-7037\(98\)00282-8](https://doi.org/10.1016/S0016-7037(98)00282-8)
- 563 Dehut, J.P., Fonsny, K., Myttenaere, C., Deprince, D., Vandecasteele, C.M., 1989.
564 Bioavailability of Tc incorporated in plant material. *Health Physics* 57, 263–267.

565 <https://doi.org/10.1097/00004032-198908000-00004>
566 Echevarria, G., Vong, P.C., Leclerc-Cessac, E., Morrel, G.L., 1997. Bioavailability of
567 technetium-99 as affected by plant species and growth, application form and soil incubation.
568 Journal of Environmental Quality 26, 947–956.
569 <https://doi.org/10.2134/jeq1997.00472425002600040004x>

570 Echevarria, G., Vong, P.C., Morrel, G.L., 1998. Effect of NO_3^- on fate of TcO_4^- in the soil-plant
571 systems. Journal of Environment Radioactivity 38, 163–171. [https://doi.org/10.1016/S0265-](https://doi.org/10.1016/S0265-931X(97)00032-5)
572 [931X\(97\)00032-5](https://doi.org/10.1016/S0265-931X(97)00032-5)

573 Echevarria, G., Morrel, G.L., Florentin, L., Leclerc-Cessac, E. 2003. Influence of climatic
574 conditions and soil type on $^{99}\text{TcO}_4^-$ uptake by rye grass. Journal of Environment Radioactivity
575 70, 85–97. [https://doi.org/10.1016/S0265-931X\(03\)00128-0](https://doi.org/10.1016/S0265-931X(03)00128-0)

576 Ewers, L.W., Eslava-Gomez, A., Brown, J., 2011. Review of Transfer of Technetium to
577 Terrestrial Crops and Animal Products. Chilton. HPA-CRCE-025. [WWW Document]. URL
578 [https://assets.publishing.service.gov.uk/government/uploads/system/uploads/attachment_data/file](https://assets.publishing.service.gov.uk/government/uploads/system/uploads/attachment_data/file/340175/HPA-CRCE-025_for_website.pdf)
579 [/340175/HPA-CRCE-025_for_website.pdf](https://assets.publishing.service.gov.uk/government/uploads/system/uploads/attachment_data/file/340175/HPA-CRCE-025_for_website.pdf)

580 Garcia-Leon, M., 2005. ^{99}Tc in the Environment: Sources, Distribution and Methods J. Nuclear
581 and Radiochemical Science, 6, 253–259. https://doi.org/10.14494/jnrs2000.6.3_253

582 Garland, T.R., Cataldo, D.A., Macfadden, K.M., Shreckhise, R.G., Wildung, R.E., 1983.
583 Comparative behavior of ^{99}Tc , ^{129}I , ^{127}I and ^{137}Cs in the environment adjacent to a fuels
584 reprocessing facility. Health Physics 44, 658–662.

585 Garten Jr., C.T., Hoffman, F.O., Bondiotti, E.A., 1984. Field and greenhouse experiments on the
586 fate of technetium in plants and soil. Health Physics, 46, 647–656.
587 <https://doi.org/10.1097/00004032-198403000-00015>

588 Garten, Jr. C.T., Tucker, C.S., 1986. Plant uptake of neptunium-237 and technetium-99 under
589 field conditions. Journal of Environment Radioactivity, 4, 91–99.
590 [https://doi.org/10.1016/0265-931X\(86\)90035-4](https://doi.org/10.1016/0265-931X(86)90035-4)

591 Green N., Wilkins B.T., Hammond D.J. and Davidson M.F., 1995. Transfer of radionuclides to
592 vegetables and other crops in an area of land reclaimed from the sea: a compilation of data.
593 Chilton, NRPB-M538. [WWW Document]. URL
594 [https://assets.publishing.service.gov.uk/government/uploads/system/uploads/attachment_data/file](https://assets.publishing.service.gov.uk/government/uploads/system/uploads/attachment_data/file/340204/HpaRpd006.pdf)
595 [/340204/HpaRpd006.pdf](https://assets.publishing.service.gov.uk/government/uploads/system/uploads/attachment_data/file/340204/HpaRpd006.pdf)

596 Henrot, J., 1989. Bioaccumulation and chemical modification of Tc by soil bacteria. Health
597 Physics 57, 239–245. <https://doi.org/10.1097/00004032-198908000-00001>

598 F. Owen. Hoffman, Charles T. Garten, Deborah M. Lucas, and John W. Huckabee, 1982.
599 Environmental behavior of technetium in soil and vegetation: implications for radiological
600 impact assessment. Environ. Sci. Technol., 16, 4, 214–217 <https://doi.org/10.1021/es00098a008>

601 International Atomic Energy Agency, 2010. Handbook of parameter values for the prediction of
602 radionuclides transfer in terrestrial and freshwater environments. TRS-472, Vienna: IAEA.
603 [WWW Document]. URL https://www-pub.iaea.org/mtcd/publications/pdf/trs472_web.pdf

604 IUSS Working Group WRB. 2015. World Reference Base for Soil Resources 2014, update 2015.
605 International soil classification system for naming soils and creating legends for soil maps.
606 World Soil Resources Reports No. 106. FAO, Rome. [WWW Document]. URL
607 <https://www.fao.org/3/i3794en/I3794en.pdf>

608 Kashparov, V., Colle, C., Zvarich, S., Levchuk, S., Yoschenko, V., Lundin, S., 2005. Soil-to-
609 plant halogens transfer studies. 1. Root uptake of radioiodine by plants. *Journal of Environmental*
610 *Radioactivity* 79, 187–204. <https://doi.org/10.1016/j.jenvrad.2004.06.005>

611 Kashparov V., Colle C., Zvarich S., Yoschenko V., Levchuk S., Lundin S. , 2005. Soil-to-plant
612 halogens transfer studies 2. Root uptake of radiochlorine by plants. *Journal of Environmental*
613 *Radioactivity* 79, 233-253. <https://doi.org/10.1016/j.jenvrad.2004.07.001>

614 Kumata, M. and Vandergraaf, T.T., 1993. Technetium behaviour under deep geological
615 conditions. *Radioactive Waste Management and the Nuclear Fuel Cycle* 17(2), p. 107.

616 Lieser, K.H., Bauscher, C., 1987. Technetium in the hydrosphere and in the geosphere, Part I.
617 *Radiochimica Acta* 42, 205–213. <https://doi.org/10.1524/ract.1987.42.4.205>

618 Mousny, J.M., Myttenaere, C., 1982. Transfer of technetium from soil to plant as a function of
619 the type of soil, mode of contamination and vegetative cover. In *Environmental Migration of*
620 *Long-Lived Radionuclides*, pp. 353-358, IAEA, Vienna.

621 Murphy, C.E., Johnson, T.L., 1993. Vegetative uptake of technetium-99 from buried, solidified,
622 low-level radioactive waste. *Journal of Radioactive Quality* 22, 793–799.
623 <https://doi.org/10.2134/jeq1993.00472425002200040022x>

624 Rosotti, H., 1998. *Diverse Atoms: Profiles of the Chemical Elements*. Oxford University Press,
625 Oxford. ISBN 9780198558156. 608 p.

626 Rößler, D., Franke, K., Süß, R., Becker, E., Kupsch, H., 2000. Synthesis and chromatographic
627 characterization of [Tc-99m] technetium-humic species. *Radiochimica Acta* 88, 95–100.
628 <https://doi.org/10.1524/ract.2000.88.2.095>

629 Shaw, G., Wadey, P., Bell, J.N.B., 2004. Radionuclide transport above a near-surface water
630 table: IV. Soil migration and crop uptake of chlorine-36 and technetium-99, 1990 to 1993.
631 *Journal of Environmental Quality* 33, 2272–2280. <https://doi.org/10.2134/jeq2004.2272>

632 Sheppard, M.I., Vandergraaf, T.T., Thibault, A., Keith-Reid, J.A., 1983. Technetium and
633 uranium: sorption by plant uptake from peat and sand. *Health Physics* 44, 635–644.
634 <https://doi.org/10.1097/00004032-198306000-00004>

635 Sheppard, S.C., Sheppard, M. I., Evenden, W.G., 1990. A novel method used to examine
636 variation in technetium sorption among 34 soils, aerated and anoxic. *Journal of Environmental*
637 *Radioactivity* 11, 215–233. [https://doi.org/10.1016/0265-931X\(90\)90016-O](https://doi.org/10.1016/0265-931X(90)90016-O)

638 Sheppard, M.I. and Thibault, D.H. 1992. Desorption and extraction of selected heavy metals
639 from soils. *Soil Science Society of America Journal* 56, 415–423.
640 <https://doi.org/10.2136/sssaj1992.03615995005600020012x>

641 Simonoff, M., Khijniak, T.V., Sergeant, C., Vesvres, M.H., Pravikoff, M.S., Leclerc-Cessac, E.,
642 Echevarria, G., Denys, S., 2003. Technetium species induced in maize as measured by
643 phosphorimager. *Journal of Environment Radioactivity* 70, 139–154.
644 [https://doi.org/10.1016/S0265-931X\(03\)00123-1](https://doi.org/10.1016/S0265-931X(03)00123-1)

645 Tagami, K., and Uchida, S., 1996. Microbial role in immobilization of technetium in soil under
646 waterlogged conditions. *Chemosphere* 33, 217–225. [https://doi.org/10.1016/0045-6535\(96\)00165-8](https://doi.org/10.1016/0045-6535(96)00165-8)

648 Tagami, K., Uchida, S., 1997. Concentration of global fallout ⁹⁹Tc in rice paddy soils collected in
649 Japan. *Environmental pollution* 95, 151–154. [https://doi.org/10.1016/S0269-7491\(96\)00124-8](https://doi.org/10.1016/S0269-7491(96)00124-8)

650 Tagami, K., Uchida, S., 1998. Aging effect on bioavailability of Mn, Co, Zn and Tc in Japanese
651 agricultural soils under waterlogged conditions. *Geoderma* 84, 3–13.
652 [https://doi.org/10.1016/S0016-7061\(97\)00117-1](https://doi.org/10.1016/S0016-7061(97)00117-1)

653 Tagami, K., Uchida, S., 1999. Chemical transformation of technetium in soil during the change
654 of soil water conditions. *Chemosphere* 38, 961–971. [https://doi.org/10.1016/S0045-
655 6535\(98\)00361-0](https://doi.org/10.1016/S0045-6535(98)00361-0)

656 Tagami, K., 2003. Technetium-99 behavior in the terrestrial environment. Field observation and
657 radiotracer experiment. *Journal of Nuclear and Radiochemical Sciences* 4, No1, A1–A8
658 <http://dx.doi.org/10.14494/jnrs2000.4.A1>

659 Tagami, K., Uchida, S., 2005. Soil-to-plant transfer factors of technetium-99 for various plants
660 collected in the Chernobyl area. *Journal of Nuclear and Radiochemical Sciences* 6, No3, 261–
661 264. http://dx.doi.org/10.14494/jnrs2000.6.3_261

662 Takahashi, Y., Minai, Y., Ambe, S., Makide, Y., Ambe, F., 1999. Comparison adsorption
663 behavior of multiple inorganic ions on kaolinite and silica in the presence of humic acid using a
664 multitracer technique. *Geochimica et Cosmochimica Acta* 63, 815–836.
665 [https://doi.org/10.1016/S0016-7037\(99\)00065-4](https://doi.org/10.1016/S0016-7037(99)00065-4)

666 Till, J.E., 1986. Source terms for technetium-99 from nuclear fuel cycle facilities. In: Desmet,
667 G., Myttenaere, C. (Eds.), *Technetium in the Environment*. Elsevier, London, 1–20.
668 https://doi.org/10.1007/978-94-009-4189-2_1

669 Van Loon, L.R., Stalmans, M., Maes, A., Cremers, A., Cogneau, M., 1986. Soil-humic acid
670 complexes of technetium: synthesis and characterization. In: Desmet, G., Myttenaere, C. (Eds.),
671 *Technetium in the environment*. Elsevier, London, 301–306. [https://doi.org/10.1007/978-94-009-
672 4189-2_12](https://doi.org/10.1007/978-94-009-4189-2_12)

673 Vandecasteele, C.M., Dehut, J.P., Van Laer, S., Deprins, D., Myttenaere, C., 1989. Long-term
674 availability of Tc deposited on soil after accidental releases. *Health Physics* 57, 247–254.
675 <https://doi.org/10.1097/00004032-198908000-00002>

676 Wildung, R. E., Garland, T. R., McFadden, K. M., Cowan, C. E., 1986. Technetium Sorption in
677 Surface Soils. In: Desmet, G., Myttenaere, C. (Eds.), *Technetium in the environment*. Elsevier,
678 London, 115–129. https://doi.org/10.1007/978-94-009-4189-2_10

679 Yanagisawa, K., Muramatsu, Y., 1993. Transfer factors of technetium from soil to vegetables.
680 *Radiochimica Acta* 63, 83–86 <https://doi.org/10.1524/ract.1993.63.special-issue.83>

681 Yanagisawa, K., Muramatsu, Y., 1995. Transfer factors of technetium from soil to paddy and
682 upland rice. *Journal of Radiation Research* 36, 171–178. <https://doi.org/10.1269/jrr.36.171>

683

684 **CAPTIONS TO TABLES**

685

686 Table 1. Average agrochemical characteristics of soils and parameters of soil composition
687 (measured in 2007).

688 Table 2. Mean values of ^{99}Tc activity concentrations (Bq kg^{-1} , DW) in the upper 0-20 cm of the
689 four soil types at the beginning and at the end of the vegetation periods used to calculate CR
690 values.

691 Table 3. Concentration ratios of ^{99}Tc in different food crops (derived on the basis of mean values
692 of the ^{99}Tc activity concentrations in the arable 20-cm soil layers at the beginning and at the end
693 of the growing periods).

694

Agrochemical characteristics *	Soil type FAO-UNESCO (CIS countries)			
	Podzoluvisol	Greyzem	Phaozem	Chernozem
	(Soddy-podzolic)	(Grey forest)	(Meadow Chernozem)	(Typical Chernozem)
	IAEA soil groups			
	Sand	Sand	Loam	Clay
Exchangeable calcium (Ca), mg-eq/100 g	1.13±0.12	6.1±0.3	12.6±0.4	24.8±1.0
Exchangeable Magnesium (Mg), mg-eq/100 g	0.13±0.01	1.6±0.1	3.4±0.05	2.9±0.1
Sum of exchangeable bases (S), mg-eq/100 g	1.0±0.1	11.8±0.2	24.3±0.5	49.6
Water extract, pH _{H2O}	4.2±0.3	6.3±0.1	6.8±0.2	7.5±0.1
Humus, %	0.8±0.2	1.1±0.1	2.8±0.2	4.0±0.2
P ₂ O ₅ , mg/kg	158	292	294	26
K ₂ O, mg/kg	72	285	264	152
Alkaline-hydrolyzed nitrogen (N _{gidr}), mg/100 g	4.1±0.3	6.9±0.5	10.0±0.5	10.8±1.0
Parameters of soil composition				
Median diameter, μm	141.2	48.9	23.2	11.6
10% mass, μm	<22.4	<3.0	<3.8	<1.7
90% mass, μm	<513	<462	<43.6	<31.6
>500 μm, % mass	8	6	0	0

696 * Arithmetic mean and SD where given

Harvested plant	Sampling Date	⁹⁹ Tc activity concentration in soil (Bq kg ⁻¹ dw)			
		Podzoluvisol	Greyzem	Phaozem	Chernozem
Radish root, lettuce	05/07/2005	110±20	130±20	140±20	130±20
Summer wheat	18/08/2005	120±30	130±30	160±30	180±40
Potatoes, bean	01/09/2005	110±20	110±20	140±20	140±20
Radish root, lettuce	07/06/2006	140±30	150±20	180±30	150±20
Summer wheat	16/08/2006	140±20	150±20	170±20	160±20
Potatoes, bean	29/08/2006	140±20	140±10	180±30	150±10
Summer wheat	16/08/2007	90±20	120±30	130±30	120±20
Potatoes	01/09/2007	80±20	100±20	120±20	90±20
Summer wheat*	31/07/2012	37±8	33±7	42±10	35±9
Summer wheat*	05/08/2013	35±7	35±7	68±14	45±9
Summer wheat*	07/08/2014	34±7	49±10	58±12	46±10

700 * ⁹⁹Tc activity concentration in soil at the end of the growth period

Plant	Plant compartment	Year	CR (mean \pm SD, n=4)			
			Podzoluvisol	Greyzem	Phaozem	Chernozem
Radish	Roots	2005	120 \pm 30	80 \pm 20	150 \pm 30	170 \pm 30
		2006	110 \pm 30	80 \pm 20	60 \pm 10	70 \pm 10
Lettuce	Leaves	2005	-	-	150 \pm 30	210 \pm 40
		2006	-	60 \pm 10	100 \pm 20	80 \pm 20
Beans	Pods	2005	10 \pm 2	12 \pm 3	7 \pm 2	15 \pm 4
		2006	80 \pm 20	30 \pm 10	4 \pm 2	5 \pm 1
Potatoes	Tubers	2005	2.2 \pm 0.6	2.3 \pm 0.7	1.9 \pm 0.5	2.3 \pm 0.6
		2006	1.4 \pm 0.3	1.0 \pm 0.2	0.6 \pm 0.2	0.9 \pm 0.2
		2007	1.2 \pm 0.4	1.0 \pm 0.3	0.4 \pm 0.1	0.5 \pm 0.1
Summer wheat	Grain	2005	0.7 \pm 0.2	0.6 \pm 0.2	0.5 \pm 0.2	0.5 \pm 0.2
		2006	0.8 \pm 0.2	0.6 \pm 0.1	0.4 \pm 0.1	0.5 \pm 0.1
		2007	0.9 \pm 0.3	0.5 \pm 0.2	0.7 \pm 0.3	0.8 \pm 0.2
		2012	0.14 \pm 0.03	0.07 \pm 0.02	0.025 \pm 0.006	0.13 \pm 0.04
		2013	0.15 \pm 0.04	0.03 \pm 0.01	0.017 \pm 0.005	0.04 \pm 0.01
		2014	0.12 \pm 0.03	0.016 \pm 0.005	0.024 \pm 0.008	0.03 \pm 0.01
		2014	0.12 \pm 0.03	0.016 \pm 0.005	0.024 \pm 0.008	0.03 \pm 0.01
	Straw	2005	26 \pm 8	20 \pm 5	33 \pm 8	32 \pm 9
		2006	30 \pm 7	18 \pm 4	17 \pm 4	16 \pm 4
		2007	32 \pm 8	18 \pm 5	16 \pm 4	45 \pm 9
2012		15 \pm 3	6.5 \pm 1.4	2.7 \pm 0.6	5.2 \pm 1.2	
		2013	18 \pm 5	4.0 \pm 1.1	2.3 \pm 0.6	4.1 \pm 1.1
		2014	14 \pm 3	3.1 \pm 0.8	2.3 \pm 0.6	5.1 \pm 1.3

705 **CAPTIONS TO FIGURES**

706

707 Fig. 1. Relative vertical distributions of ^{99}Tc in soil profiles 1 week and 4 months after the first
708 administration of ^{99}Tc to soil. The inventory of ^{99}Tc in each soil layer has been normalized to the
709 total ^{99}Tc inventory present in the profile at the time of sampling.

710

711 Fig. 2. Relative vertical distributions of ^{99}Tc in soil profiles 1 year after the 1st administration
712 (2006) and 2nd administration (2007). The distributions have been normalized to the initial
713 amount of ^{99}Tc administered.

714

715 Fig. 3. Time dependences of ^{99}Tc concentration ratio values for wheat grain and straw.

716

717

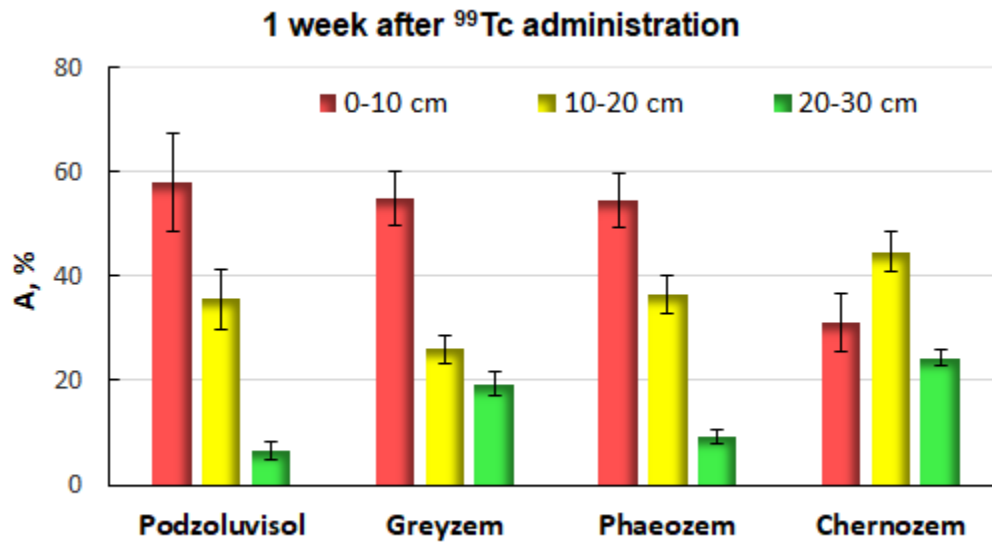

718

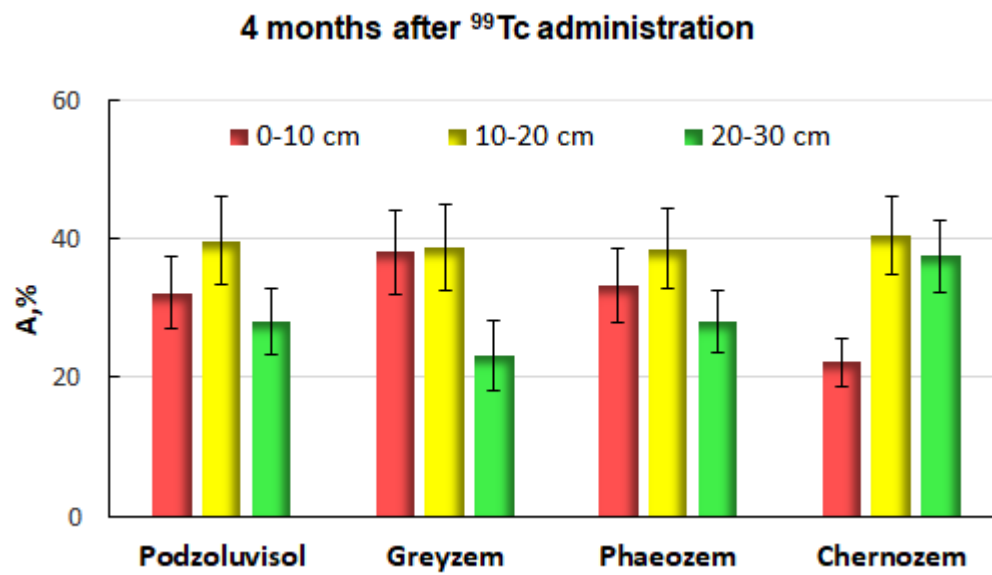

719

720 Fig. 1

721

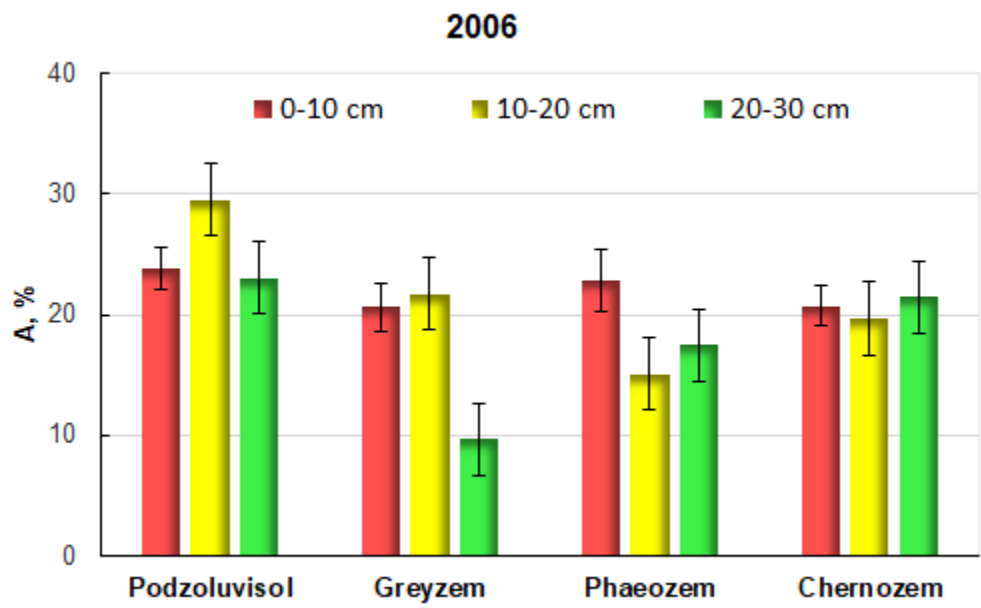

722

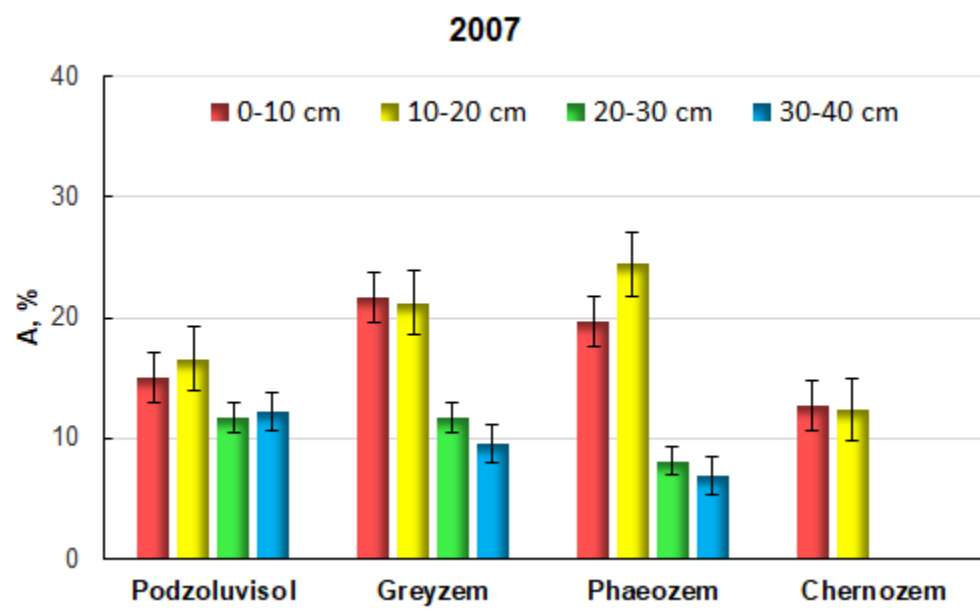

723

724 Fig. 2

725

726

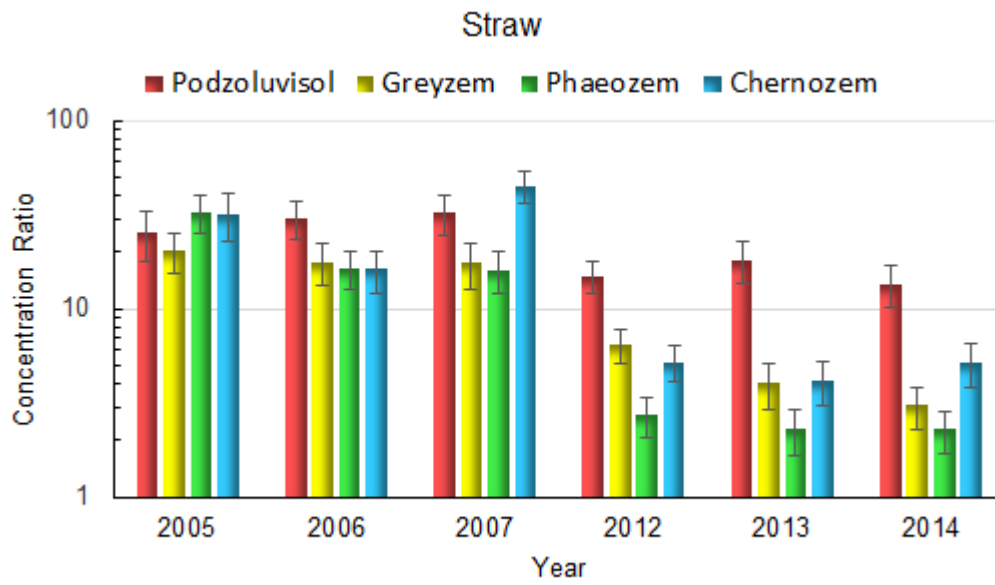

727

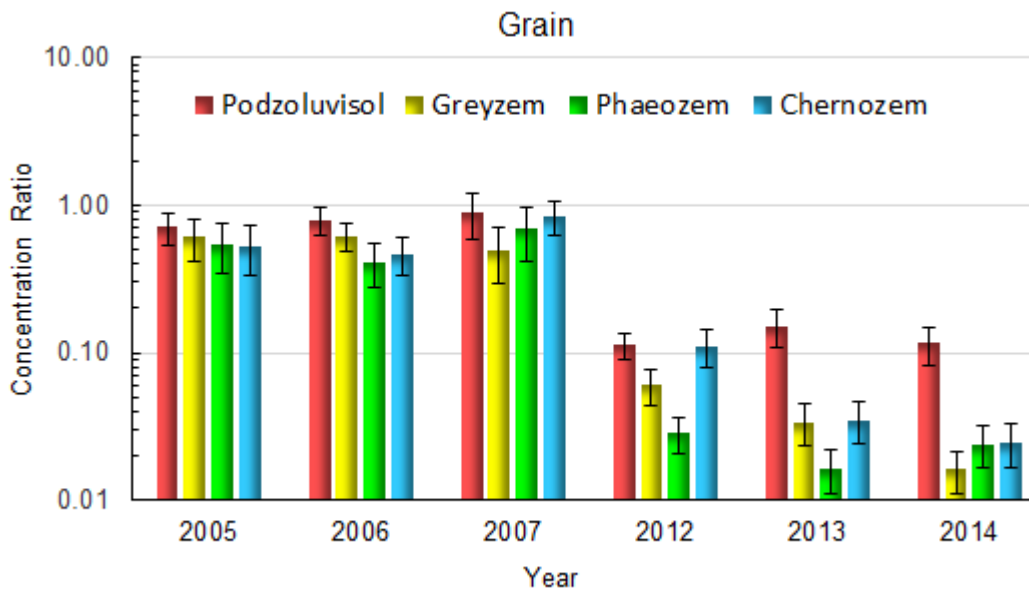

728

729 Fig. 3

730 **Supplementary Information**

731



732

733

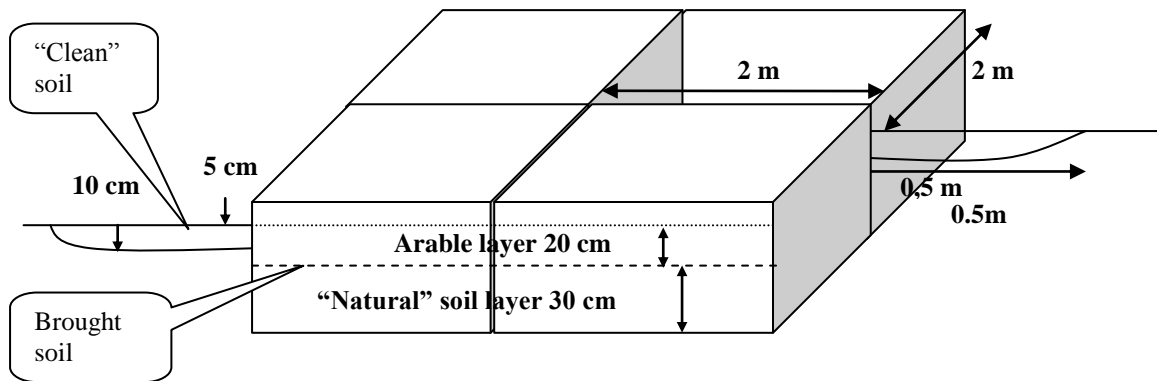

734



735

736 Figure S1 - Setup of the experimental plot in the Chernobyl Exclusion Zone for radionuclide root
737 uptake studies (2000)

738



739

740

741 Figure S2 – Radionuclide administration in containers with Podzoluvisol (an example).

742



743
744
745
746

Figure S3 – Crop rotations across the sequence of growing seasons. In 2012-2014 summer wheat was planted in each container used before.

747

748 Table S1 – Vertical distribution of ⁹⁹Tc in soil profiles at different times after administration

Layer	Podzoluvisol		Greyzem		Phaeozem		Chernozem	
	A, Bq/kg	U, Bq/kg	A, Bq/kg	U, Bq/kg	A, Bq/kg	U, Bq/kg	A, Bq/kg	U, Bq/kg
1 week after first administration (23.05.2005)								
0-10 cm	140	24	165	26	170	27	107	19
10-20 cm	90	14	75	14	110	18	170	27
20-30 cm	17	3	60	11	29	6	89	18
4 months after first administration (01.09.2005)								
0-10 cm	86	14	108	17	138	17	87	14
10-20 cm	108	18	111	18	155	18	150	22
20-30 cm	63	13	68	15	110	14	135	20
1 year after first administration (26.04.2006)								
0-10 cm	62	9	59	11	76	17	64	10
10-20 cm	83	12	60	9	48	12	60	10
20-30 cm	57	8	29	4	52	8	64	13
2 years after first administration (18.04.2007)								
0-10 cm	73	12	111	19	130	20	89	30
10-20 cm	75	12	108	17	118	19	95	30
20-30 cm	63	11	56	9	46	7	x	
30-40 cm	51	8	50	8	36	6	x	

749 U – uncertainty of measurement (p=0.95)

750 x –not collected

751

752

753 Table S2 – Values of compartment inventories at the end of the growing periods

Plant	Compartment	Year	Inventory \pm U (p=0.95), %			
			Podzoluvisol	Greyzem	Phaeozem	Chernozem
Radish	Roots		0.9 \pm 0.1	1.4 \pm 0.2	2.2 \pm 0.2	2.7 \pm 0.3
Lettuce	Leaves	2005	-	-	6.1 \pm 0.7	9.4 \pm 0.9
	Soil ¹		86 \pm 17	92 \pm 17	72 \pm 14	52 \pm 13
Radish	Roots		1.1 \pm 0.2	1.9 \pm 0.3	1.4 \pm 0.2	1.2 \pm 0.2
Lettuce	Leaves	2006	-	1.4 \pm 0.3	2.6 \pm 0.4	4.3 \pm 0.7
	Soil ¹		53 \pm 15	45 \pm 9	54 \pm 12	28 \pm 3
Beans	Pods		0.18 \pm 0.04	0.5 \pm 0.1	0.5 \pm 0.1	0.5 \pm 0.1
Potatoes	Tubers	2005	0.3 \pm 0.1	0.3 \pm 0.1	0.4 \pm 0.1	0.7 \pm 0.3
	Soil		86 \pm 17	58 \pm 17	72 \pm 14	65 \pm 11
Beans	Pods		0.6 \pm 0.1	0.3 \pm 0.1	0.3 \pm 0.1	0.24 \pm 0.04
Potatoes	Tubers	2006	0.19 \pm 0.03	0.20 \pm 0.04	0.17 \pm 0.05	0.23 \pm 0.06
	Soil ¹		48 \pm 10	40 \pm 4	58 \pm 12	45 \pm 13
Summer	Grain		0.06 \pm 0.01	0.07 \pm 0.02	0.08 \pm 0.01	0.07 \pm 0.02
wheat	Straw	2005	2.3 \pm 0.6	2.6 \pm 0.5	4.7 \pm 0.9	4.5 \pm 1.1
	Soil ¹		94 \pm 26	92 \pm 25	88 \pm 22	98 \pm 21
Summer	Grain		0.06 \pm 0.01	0.07 \pm 0.01	0.05 \pm 0.01	0.06 \pm 0.02
wheat	Straw	2006	2.0 \pm 0.3	2.0 \pm 0.4	2.0 \pm 0.4	2.3 \pm 0.5
	Soil ¹		44 \pm 10	49 \pm 9	50 \pm 8	34 \pm 11

754 1- derived on the basis of values of the ⁹⁹Tc activity concentrations in the arable 20-cm soil layers at the
755 end of the growing period

756

757

758

759 Table S3 – Concentration ratios of ^{99}Tc in different food crops (derived on the basis of values of
 760 the ^{99}Tc activity concentrations in the arable 20-cm soil layers at the beginning of the growing
 761 periods).

Plant	Plant compartment	Year	CR (mean \pm SD, n=4)			
			Podzoluvisol	Greyzem	Phaeozem	Chernozem
Radish	Roots	2005	90 \pm 20	61 \pm 13	120 \pm 20	140 \pm 20
		2006	90 \pm 20	65 \pm 15	50 \pm 10	50 \pm 8
Lettuce	Leaves	2005	-	-	120 \pm 20	210 \pm 30
		2006	-	46 \pm 6	80 \pm 10	56 \pm 12
Beans	Pods	2005	4 \pm 1	7 \pm 2	5 \pm 1	14 \pm 3
		2006	60 \pm 10	24 \pm 7	3 \pm 1	3 \pm 1
Potatoes	Tubers	2005	1.6 \pm 0.4	1.4 \pm 0.5	1.4 \pm 0.4	2.0 \pm 0.5
		2006	1.1 \pm 0.2	0.7 \pm 0.1	0.5 \pm 0.1	0.6 \pm 0.1
		2007	0.5 \pm 0.2	0.5 \pm 0.2	0.2 \pm 0.1	0.4 \pm 0.1
Summer wheat	Grain	2005	0.7 \pm 0.2	0.5 \pm 0.2	0.5 \pm 0.1	0.5 \pm 0.2
		2006	0.6 \pm 0.1	0.5 \pm 0.1	0.3 \pm 0.1	0.3 \pm 0.1
		2007	0.4 \pm 0.2	0.3 \pm 0.1	0.4 \pm 0.2	0.4 \pm 0.1
	Straw	2005	24 \pm 5	17 \pm 4	30 \pm 5	32 \pm 9
		2006	23 \pm 5	14 \pm 3	13 \pm 3	12 \pm 3
		2007	16 \pm 6	11 \pm 3	10 \pm 3	24 \pm 5

762

763

764 Table S4 – Concentration ratios of ⁹⁹Tc in different food crops (derived on the basis of values of
 765 the ⁹⁹Tc activity concentrations in the arable 20-cm soil layers at the end of the growing periods).
 766

Plant	Plant compartment	Year	CR (mean ±SD, n=4)			
			Podzoluvisol	Greyzem	Phaeozem	Chernozem
Radish	Roots	2005	150±20	99±13	180±20	200±25
		2006	130±20	95±15	70±10	90±8
Lettuce	Leaves	2005	-	-	180±20	210±20
		2006	-	74±8	120±20	104±15
Beans	Pods	2005	16±2	17±2	9±2	16±2
		2006	100±15	36±7	5±2	6.8±0.7
Potatoes	Tubers	2005	2.8±0.4	3.2±0.4	2.4±0.4	2.6±0.4
		2006	1.7±0.2	1.3±0.2	0.7±0.2	1.2±0.2
		2007	1.9±0.3	1.5±0.2	0.6±0.1	1.4±0.3
Summer wheat	Grain	2005	0.7±0.2	0.7±0.15	0.5±0.1	0.5±0.1
		2006	1.0±0.2	0.7±0.1	0.5±0.1	0.7±0.1
		2007	1.4±0.2	0.7±0.15	1.0±0.2	1.2±0.2
	Straw	2005	28±7	23±3	36±6	32±9
		2006	37±5	22±3	21±3	20±3
		2007	48±5	25±4	22±3	66±7

767

768